

# ELECTRIC BIKE CO.

EST. 2014

## OPERATOR'S MANUAL

Version 2.4 | 2025

[www.electricbikecompany.com](http://www.electricbikecompany.com)

# TABLE OF CONTENTS

INTRODUCTION.....	6
WARNINGS AND CAUTION STATEMENTS.....	7
QUICK START GUIDE.....	11
GENERAL SAFETY.....	20
USE – BEACH CRUISER.....	21
SINGLE RIDER ONLY.....	21
WEIGHT CAPACITY.....	21
RETROFITTING.....	22
CARRYING CARGO.....	22
VEHICLE RACKS.....	22
PEDAL ASSIST.....	22
HELMET USAGE.....	22
MECHANICAL SAFETY CHECK.....	24
SMALL BICYCLE ACCESSORIES AND CHOKING HAZARD.....	24
TECHNICAL SUPPORT.....	24
USING GOOD JUDGMENT.....	24
WARNING: A SPECIAL NOTE TO PARENTS.....	25
RIDING YOUR EBC BIKE/OPERATING PROCEDURES:.....	26
CHARGING YOUR BATTERY.....	26
BATTERY POSITION ON BIKE:.....	28
OPERATING YOUR BIKE THROUGH YOUR LCD DISPLAY.....	30
QUICK START GUIDELINES FOR USING PEDAL ASSIST.....	31
ACTIVATING HEAD AND TAIL LIGHTS.....	32
BATTERY RANGE.....	32
PEDAL ASSIST MODE – DETAILED INSTRUCTIONS FOR USE.....	34
HAND THROTTLE CONTROL.....	37
BRAKES.....	37
ELECTRIC BIKE SERVICE AND MAINTENANCE GUIDELINES.....	39

SERVICE.....	39
TORQUE SPECIFICATIONS.....	42
MAINTENANCE.....	43
BIKE RIDING - GENERAL SAFETY.....	46
ADDITIONAL SAFETY MEASURES FOR RIDING ELECTRIC BIKES.....	50
CHECKLIST: BEFORE YOU RIDE YOUR EBC BIKE.....	52
PART I: Introduction to and Safe Use of Your Non-Electric Components....	52
Brake Check:.....	52
Disc Brakes:.....	52
Brake Controls and Features:.....	53
Shifting Gears:.....	53
Tire and Wheel Safety:.....	54
Bike Fit:.....	56
Stem, Handlebars, Ends and Grips:.....	56
Bolts and Nuts:.....	58
Saddle:.....	59
Pedals.....	60
Kickstand.....	61
Keys.....	61
General.....	61
PART II: Introduction to and Safe Use of Your Electric Components.....	61
Motor:.....	61
Pedal Assist Sensor ("PAS"):.....	62
Throttle:.....	62
Brake Disconnect Switch:.....	62
Battery: Important Safety Warnings.....	62
What To Do When You First Purchase Your New EBC battery:.....	63
- Internal Battery Charging:.....	63
- Charging with External Smart Charger:.....	64

- Safety Guidelines for Charging:.....	64
- After Charging:.....	64
- Battery and Charger Care.....	65
Troubleshooting.....	65
BATTERY MAINTENANCE AND SAFETY.....	66
APPEARANCE AND CARE.....	69
IF YOU HAVE AN ACCIDENT, DROP YOUR BIKE OR IT FALLS OVER:.....	69
TROUBLESHOOTING.....	72
ELECTRIC BIKE FAQs.....	74
THE LIFESPAN OF YOUR ELECTRIC BIKE AND ITS COMPONENTS.....	77
WARRANTY INFORMATION.....	78
LIMITED WARRANTY.....	78
LIMITATIONS ON WARRANTY:.....	80
TERMS AND CONDITIONS OF PURCHASE AND USE.....	83

# DESIGN YOUR ELECTRIC BIKE, YOUR WAY

THANK YOU FOR YOUR PURCHASE OF AN EBC EBIKE.

We appreciate your business, and we hope you  
thoroughly enjoy riding your new EBC eBike.

## WE LOVE HEARING FROM YOU ... LET'S TALK

We're here to help and can answer any questions you may have. Please fill out our online  
form and we'll get back to you as soon as we can at  
<https://electricbikecompany.com/contact/>.

If you need any assistance, please do not hesitate to reach out to us.

**Electric Bike Company  
Newport Beach Showroom**

1510 Newport Blvd  
Newport Beach, CA 92627

(949) 877-8606

**Electric Bike Company  
Factory & Showroom**

1945 Placentia Ave, Unit A  
Costa Mesa, CA 92627

(949) 264-4080

# INTRODUCTION

Thank you for choosing an Electric Bike Company bike. Our number one focus is to make you aware of the dangers of riding a bicycle and especially an electric bicycle so you can ensure you have a safe and enjoyable riding experience for years to come.

**IMPORTANT:** This manual is intended for all models manufactured before September 27, 2024. Please read this manual in its entirety before riding your bike or allowing anyone else to ride your bike, including the **TERMS AND CONDITIONS** contained at the end of the manual, which you agreed to abide by as part of your EBC purchase process. This manual and the **TERMS AND CONDITIONS** include important safety instructions and warnings regarding the use, charging and proper e-bike maintenance practices. All others should read this manual in its entirety before you allow them to ride your bike.

If you have any concerns, questions, or suggestions about your electric bike, please contact us at [info@electricbikecompany.com](mailto:info@electricbikecompany.com) Again, thanks for choosing the Electric Bike Company!

# IMPORTANT SAFETY INSTRUCTIONS: WARNINGS AND CAUTION STATEMENTS



Electric Bikes can be dangerous to use. The user or consumer assumes all risk of personal injuries, damage, or failure of the bicycle or system and all other losses or damages to themselves and others and to any property arising out of or as a result of using the bicycle.

As with all mechanical components, your bicycle is subjected to wear and high stresses. Different materials and components may react to wear or stress fatigue in different ways. If the designed life of a component has been exceeded, it may suddenly fail, possibly causing injuries to the rider. Any form of crack, scratches or change of coloring in highly stressed areas indicate the life of the component has been reached and should be replaced.

If you have an impairment or disability such as visual impairment, hearing impairment, physical impairment, cognitive/language impairment, and/or a seizure disorder, consult your physician before riding our bikes.

For replacement parts, technical information and warranty assistance, please contact Electric Bike Company at (949) 264-4080 or [info@electricbikecompany.com](mailto:info@electricbikecompany.com)

PLEASE NOTE: THIS MANUAL IS NOT INTENDED AS A DETAILED USER, SERVICE, REPAIR OR MAINTENANCE MANUAL. PLEASE SEEK ASSISTANCE FROM A QUALIFIED TECHNICIAN FOR SERVICE, REPAIRS OR MAINTENANCE. YOUR INSURANCE POLICIES MAY NOT PROVIDE COVERAGE FOR ACCIDENTS INVOLVING THE USE OF THIS BICYCLE. TO DETERMINE IF COVERAGE IS PROVIDED YOU SHOULD CONTACT YOUR INSURANCE COMPANY OR AGENT. DO NOT DISASSEMBLE, MODIFY OR REPLACE ELECTRICAL PARTS.

This manual contains many "Warnings" and "Cautions" concerning the consequences of failure to maintain or inspect your bicycle and of failure to follow safe cycling, maintenance, or battery charging practices.



The Caution symbol (above) can be seen throughout this Manual, and indicates a potentially hazardous situation which, if not avoided, could result in serious injury or death, or is an alert against unsafe practices.

Many of the Warnings and Cautions say, "You may lose control and fall." Because any fall can result in serious injury or even death, we do not always repeat the warning of possible injury or death, and if we do not, please assume this is the case, as all bicycles, including electric bikes, are dangerous and their safe use requires constant and consistent maintenance and care.

Please ensure that prior to each and every ride (without exception), each electric bike rider reviews the safety requirements enumerated throughout this manual, and if any problems are observed, they should be resolved prior to use.

Because it is impossible to anticipate every situation or condition which can occur while riding, this Manual makes no representation about the safe use of this Electric Bike under all conditions. There are risks associated with the use of any bicycle which cannot be predicted or avoided, and which may be caused and/or prevented through the actions of the rider, and which are the sole responsibility of the rider.

You should save this Manual along with any other documents that were included with your bicycle purchase for future reference, including the manuals provided electronically on the EBC website by the manufacturers of the motor, battery, and any other components. You should read and become familiar with the contents of these additional manuals as well before riding your bicycle.



All content in this Manual is subject to change or withdrawal without notice. Visit [www.electricbikecompany.com](http://www.electricbikecompany.com) to download the latest version. EBC assumes no responsibility or liability for any errors or inaccuracies that may inadvertently appear herein.

#### LEGALITY

In the United States, electric bikes are defined as a two- or three wheeled vehicle with fully operable pedals and an electric motor of less than 750 watts (1hp) whose maximum speed on the paved level surface when powered solely by such a motor while ridden by an operator who weighs 170 pounds, is less than 20mph.

Local and state regulations vary. It is your responsibility to ensure your bike is legal in your area before riding it on public roads. If you're unsure, ask your bicycle dealer for more information about local laws and regulations.

The following "Quick Start Guide" was provided to you as a separate document upon the purchase of your EBC e-bike. This Guide instructs you on how to tighten and adjust the EBC handlebars in the event your bike was shipped to you and requires minor assembly. It also provides trouble-shooting tips and important warnings and instructions related to battery charging and maintenance. Please review the Quick Start Guide in its entirety before riding your EBC e-bike.

# QUICK START GUIDE

Please read the following handlebar adjustment instructions carefully.

**WARNING:** Do not over tighten the bolt when following the instructions below. Overtighten the bolt may damage the stem to fork assembly and create the risk of injury to the rider.

## 1. Adjust and Position Handlebars – Step 1

Locate the stem of the bike as shown below, which is near the handlebars and take off the stem bolt cap. After taking the cap off, use the 6 mm Allen key that came with your bike and loosen the stem bolt by rotating it counterclockwise. While keeping the wheels straight, move the handlebars to align with the front wheel of the bike. Once it is straight, tighten the stem bolt using your 6 mm Allen key by rotating it

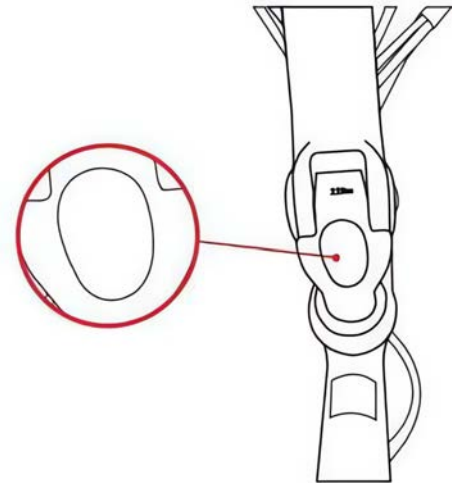

## 2. Adjust and Position Handlebars – Step 2

Locate the back of the handlebar clamp and loosen the 4 bolts as shown below. Use the 5 mm Allen key that came with your bike to loosen the bolts. Once the bolts are loosened, you will be able to set your handlebars to your desired position. Once the handlebars are set to your desired position, tighten the 4 bolts located near the back of the LCD Screen. Make sure the 4 bolts are fastened to 14 Nm.

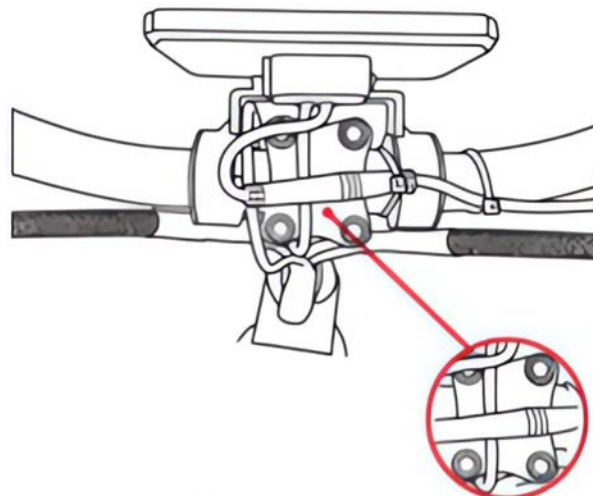

### 3. Adjust Stem Angle (Optional).

Locate the stem angle bolt as shown below. Use the 5 mm Allen key that came with your bike to loosen the bolt. Once loosened, you will be able to adjust the angle to your preference. Once set, fasten the stem angle bolt to 13 Nm.

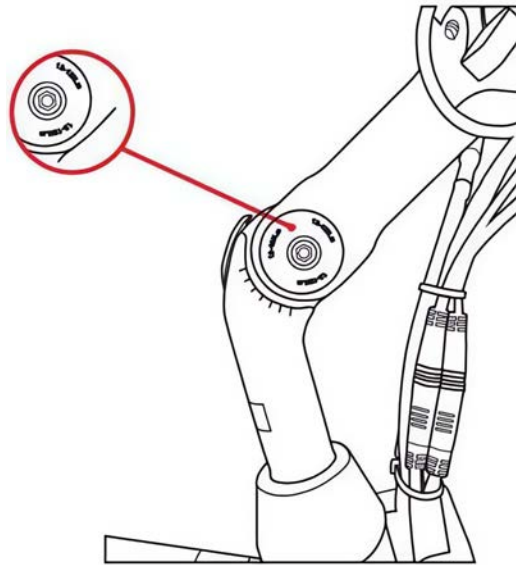

### 4. LCD Screen Adjustment.

Bring the LCD display screen forward as shown below to an approximate 45° angle or any other angle that you prefer.

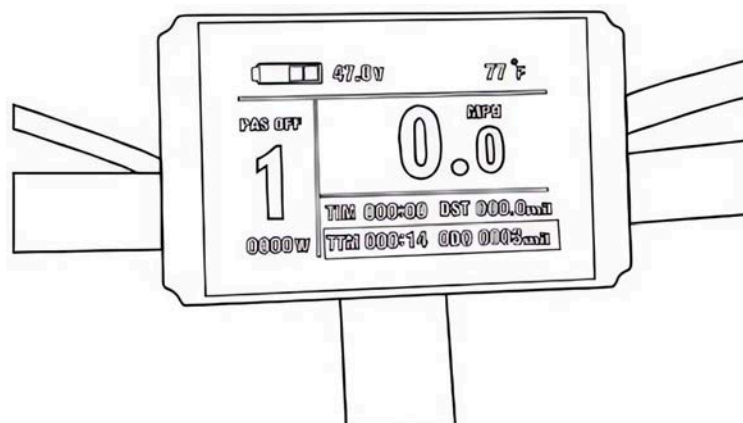

## 5. Master Switch.

Turn the master switch on as shown below.

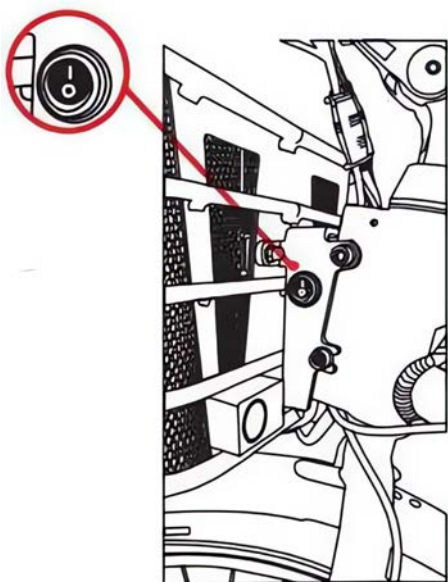

Model Y

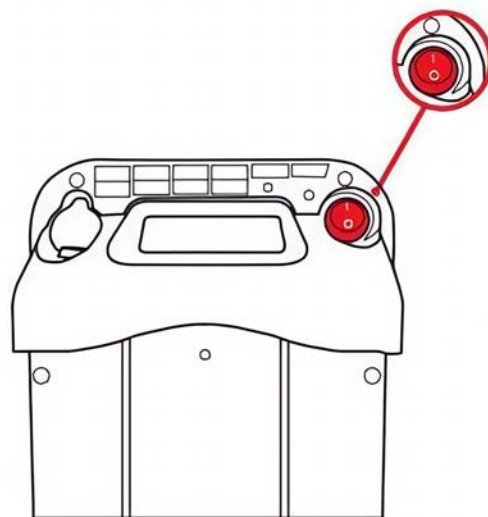

Model C & S

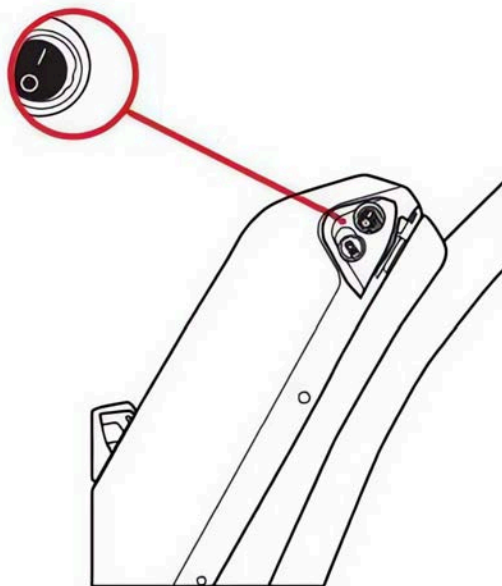

Model X & A

**Model R, E & F** - Do not have a master switch.

If the LCD screen is turned off, the battery is in sleep mode.

## 6. Turn Bike On.

Press the power button for approx. 1 second, to turn on the LCD screen controller. The power button is located on the left side of the handlebars.

**Note:** Remember the throttle is now live!

### Troubleshooting: Sleep Mode

If the battery has been left for a while it will automatically go into "sleep mode". You will need to turn the master power switch "on" and "off", then "on" again to wake up the battery. Next, turn on the power switch at the handlebars. If the battery is charged, the bike is ready to ride.

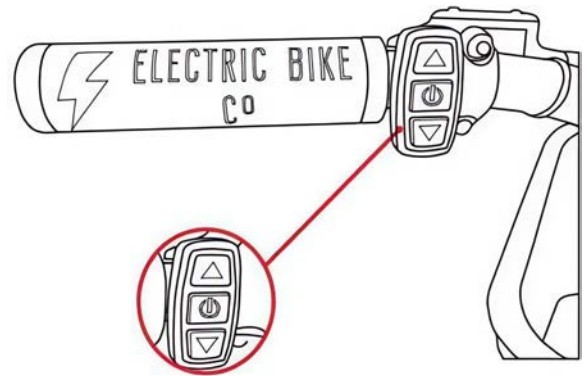

## 7. Riding in Throttle Mode.

With the LCD display screen ON, you are ready to ride in throttle mode. Hold down the throttle as shown below to move the bike forward. The throttle is set at the first level.

**Reminder:** Throttle is always live when turning on your bike.

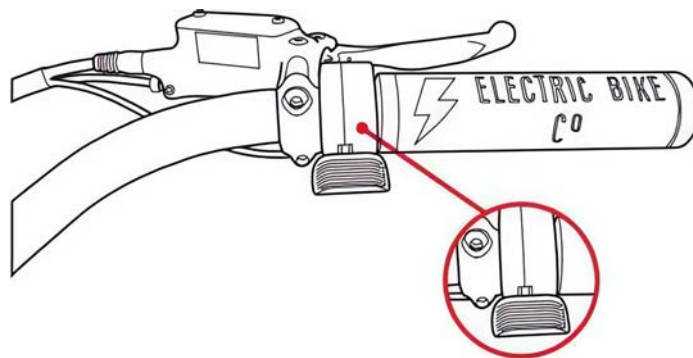

## 8. Charging

Your bike comes with a charger inside the white box marked “Charger” for the X, Y, R, E, F, A and current C & S Models. Connect the power cord to the charger. Plug the power cord into a 3-prong outlet, and plug the charger into the charging port of your bike, as shown below. The LED lights will turn red while charging and green once charging is complete.

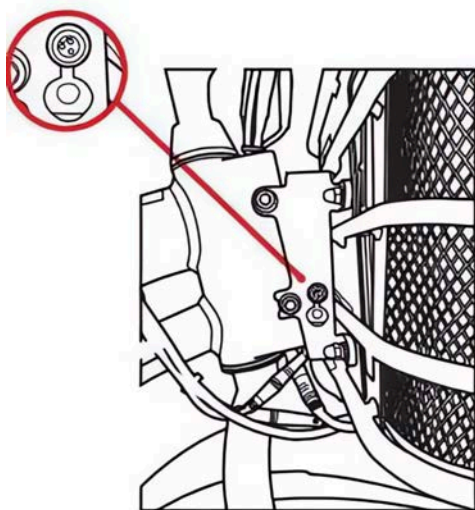

Model Y

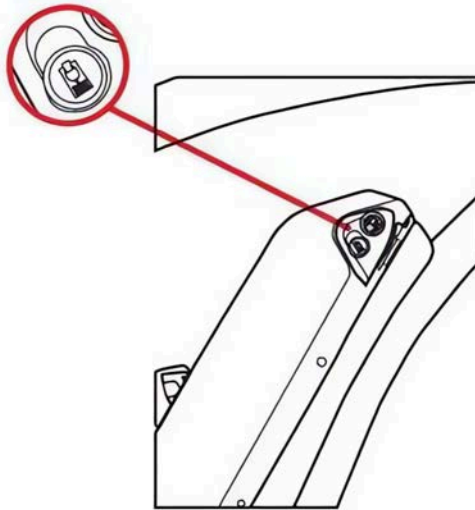

Model X & A

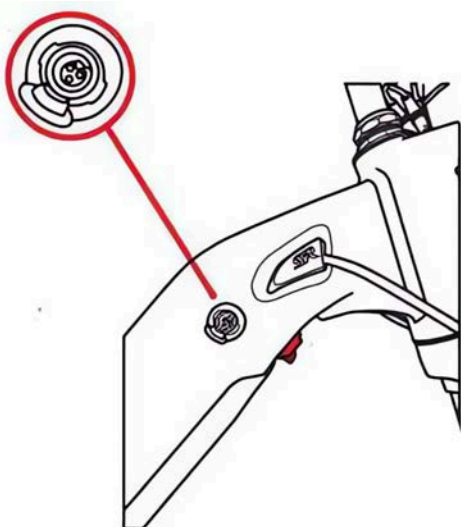

Model R & E

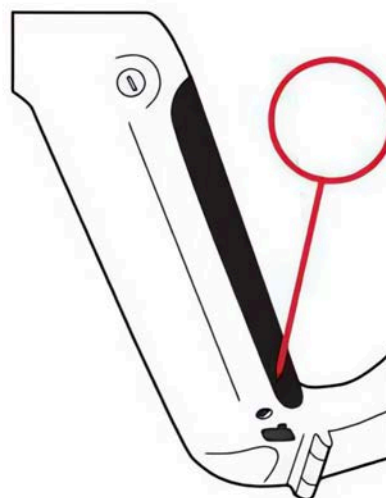

Model F

**Note:** Models X, R, E & A  
The Battery can be removed from the bike frame for charging.

## Using Pedal Assist

To turn ON Pedal Assist mode, press and hold the down arrow on the power button for approximately 3 seconds. The word "PAS off" will disappear on the display screen. Using the Up and Down arrows, you can set Pedal Assist from 0 to 5 speed modes. 1 is the slowest and 5 is the fastest.

With Pedal Assist Mode On, the motor will now turn on when you begin pedaling, and you will not need to use the throttle. You do have the ability, however, to increase your speed with throttle application while using Pedal Assist Mode.

**Note: It takes about 1 pedal rotation before Pedal Assist kicks in and turns the motor on.**

**Important:** In the beginning, as you are getting used to the bike, it is always best to start out in Mode 1 and move up to the faster modes as you are riding. In zero mode, the Pedal Assist and the throttle are not active.

## 9. Charging the Legacy Models C & S

### Method 1

Locate the power cord on the left side of the rear rack battery case and extend it to plug into a 3-prong power outlet.

### Method 2

Purchase the 3.5 amp Smart Super Charger to charge your bike. Connect the power cord to the charger. Plug the power cord into a 3-prong outlet and the charging port of your charger to the charging port of your bike, as shown below. The LED lights will turn red while charging and green once charging is complete.

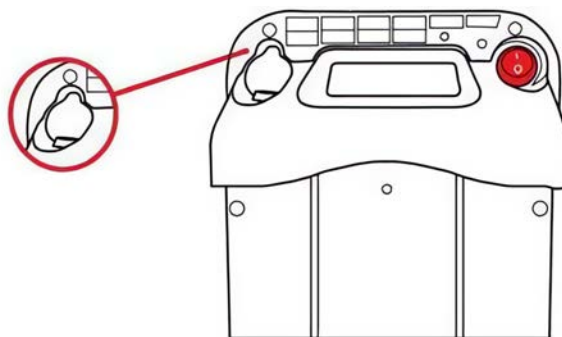

Model C & S



**Note:** You can remove the battery from the rear rack case to charge it.

### Activating Head and Tail Lights:

To turn On and Off the head and tail lights, simply press and hold the Up arrow on the power button for approximately 3 seconds until you see the display light up.

**Note:** Nm stands for "Newton Metre". Please use a torque wrench to fasten the bolts to the recommended Nm adjustment.

### 10. Charging the Models C & S

To fold the bike, please follow these step-by-step instructions.

#### Step 1.

Push the pedals inwards and lift them up as shown below.

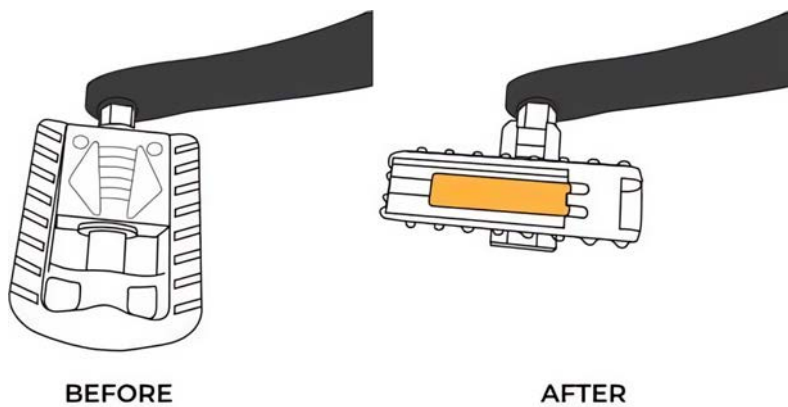

#### Step 2.

Lift the red button by the stem of the handlebars as shown and push the handlebars downwards to the side of the bike.

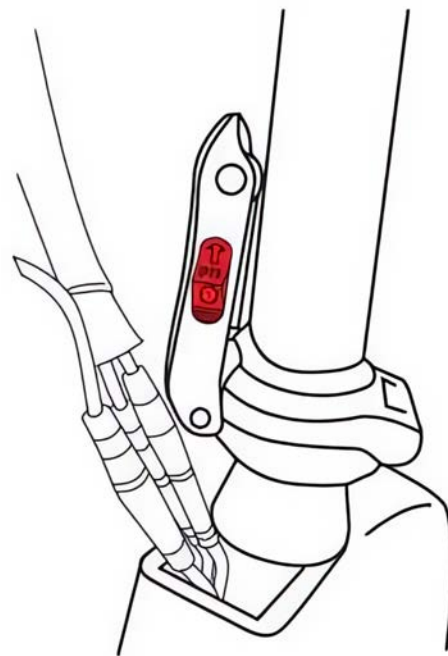

### Step 3.

Lift the kickstand up so that it does not get in the way when folding.

### Step 4.

Push the red button shown below and then pull the black lever.

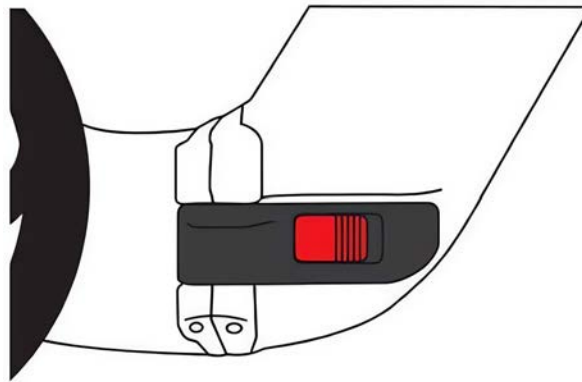

### Step 5.

Pull the bike from the other side of where the red latch is located, to fold the bike and gently rest on the ground.

**Scan QR code to watch Model F folding video with instructions.**



## BATTERY CHARGING

### IMPORTANT SAFETY INFORMATION AND WARRANTY DETAILS

**\*\*\*Consumers must always charge his/her battery every 2-3 weeks when not in use. EBC strongly recommends that after 2 years, customers send their batteries to EBC for service or replacement.**

**\*\*\*Use a regular wall outlet to charge your battery. Do not use any other type of outlet, such as an RV outlet or a converter or an inverter, or any other charger not recommended by EBC. Failure to comply with these instructions could lead to catastrophic consequences, including but not limited to battery malfunction, sparking, explosion or a battery fire. EBC is not responsible or liable for any damage caused by battery misuse and/or charging the battery in any other manner than per EBC instructions.**

EBC offers a 2 year warranty against manufacturer defects, but if the consumer fails to charge the battery regularly and it goes dead overtime – the consumer will not be able to recharge him or herself. Consumers will either need to purchase a new battery or send the battery back to EBC for repair. Consumers can either drop off and pick up the battery for free or pay for shipment of the battery to be shipped to and from our location for repair. There is no repair cost or exchange cost to fix or exchange the battery within the first 30 days if malfunction is determined to be due to a manufacturer defect. After 30 days, the parts for each battery repair cost will be waived and all warranty related labor charges will be at the standard EBC rate if the customer drops off their battery or ships it back at their expense, including a return label. A return label must be included. If a consumer opts to exchange the battery instead of having it repaired, the cost of an exchange is \$399 for a standard battery and \$499 for an upgraded battery. Consumers will receive a new battery and EBC will retain the old battery.

Consumers are responsible for the shipping costs of a battery exchange. After 2 years, consumers will need to pay the full retail price of a new standard or upgraded battery.

Water damage is not covered under this warranty.

#### ***Reminder***

*Before you begin your ride, please check to see if your disc brake on your front wheel matches the one that is on the back of your bike.*

**Please contact our Customer Support team to set up a battery exchange.**

**Remember: Charge the battery immediately after a long ride, shut off the power. In periods of non use, be sure to charge the battery every 2-3 weeks.**

# GENERAL SAFETY



When operating your bike, it is critical that you know how to properly care for each part or your bike as well as your whole bike. Please ensure you have familiarized yourself with all aspects of your bike functions and operations before riding it – ESPECIALLY on the open road with other traffic.

Since Electric Bikes are VERY different from regular bikes, please be sure to read the section on “RIDING ELECTRIC BIKES” as well as this entire manual.

NEVER operate your bicycle when you are under the influence of alcohol or drugs, including prescribed or over the counter medications.

Always Ride at a speed appropriate for the conditions. High speed means higher risk. It is your responsibility to familiarize yourself and comply with the applicable biking laws within the country, state, county, province and/or city where you will be riding.

Be careful to keep your body parts and other objects away from the sharp teeth of the chain rings, the moving chain, the turning pedals and the crank, and the spinning wheels of your bicycle.



**Use a regular wall outlet to charge your battery. Do not use any other type of outlet, such as an RV outlet or a converter or an inverter, or any other charger not recommended by EBC.** Failure to comply with these instructions could lead to catastrophic consequences, including but not limited to battery malfunction, sparking, explosion or a battery fire. EBC is not responsible or liable for any damage caused by battery misuse and/or charging the battery in any other manner than per EBC instructions.

## **USE – BEACH CRUISER**

Electric Bike Company bikes are designed to be ridden on paved roads or surfaces only. The bike is not designed to withstand off-road conditions or uneven terrain. EBC assumes no liability for any accident, injuries, or property damage incurred as a result of rider's use or misuse of EBC bicycles, including any damages resulting from or arising out of off-road usage.

An Electric Bike is not a mountain bike, racing bike, or BMX bike – Riders who do jumping, stunts, wheelies, and bike tricks should never be on this bike and can cause harm to themselves and others - and putting undue, unintended, or unnecessary stress on the bike parts, frame, brakes handlebars, stem, or forks can cause these components and/or the bike to fail, causing serious injury or death. DO NOT USE THIS BIKE FOR JUMPING over curbs, riding on mountainous or off-road trails, or any use other than for commuting and cruising in a relaxed, safe manner.

## **SINGLE RIDER ONLY**

Electric Bike Company bikes are designed for one passenger only. DO NOT carry any additional passengers on the front or rear of the bike. The rear rack is not designed to carry the weight of any additional passengers, except a baby carrier with maximum load of 40 pounds. Standing, kneeling, or sitting backwards or sideways (both legs on the same side of the bike) on the carrier seat while the bike is moving or stopped can easily result in broken limbs, loss of control of the bike, destroyed rims, a destroyed bike frame, or worse.

## **WEIGHT CAPACITY**

Electric Bike Company Electric Bikes are designed with a maximum weight capacity of 350 pounds for all models. The rear rack maximum weight capacity is 40 pounds. Exceeding the maximum weight capacity can result in damage to the bike, which can lead to serious injury or death.

## **RETROFITTING**

Never retrofit EBC bikes with any bike components that are not approved in writing by EBC. This includes tires and tubes. EBC Bikes are fitted with tires appropriate for e-bike use – never use any other tire unless approved by EBC in writing. Serious Injury and even death can result in unauthorized retrofitting.

## **CARRYING CARGO**

You should get accustomed to carrying a load on an E-bike. Practice maneuvering and braking on a flat, hazard and traffic free street with and without a load before going out into the world. Carrying a seated passenger or heavy load involves risks, foremost of which can be decreased braking power and increased stopping distance.

## **VEHICLE RACKS**

Misuse of vehicle racks could result in a potential hazardous situation which, if not avoided, could result in serious injury or death. Be sure to read and follow the instructions provided by the rack manufacturer for more complete information.

## **PEDAL ASSIST**

- When you are in PAS mode – Do not pedal at a high speed around corners – you will get a boost and your pedal may hit the ground and can cause injury or death!
- Do not use pedal assist on level and downhill grades if people are visible on the path or boardwalk.
- Do not use pedal assist if small children or pets are within 100 feet.

## **HELMET USAGE**

- Always wear a helmet and ensure it fits according to the manufacturers' instructions.
- Ensure your helmet meets the latest CPSC certification standards and is appropriate for the type of riding you do – and if there are any special requirements for riding an electric bike.
- Most serious bicycle injuries involve head injuries, which might have been avoided if the

rider had worn an appropriate helmet. FAILURE to wear a helmet when riding may result in serious injury or death.



## **MECHANICAL SAFETY CHECK**

- Check the condition of your Electric Bike before every ride.
- Make sure no nuts, bolts or fixings are loose, and pay particular attention to the axle, nuts and handlebar stem.
- Make sure the tires are correctly inflated with the recommended air pressure, which can be found on the rim of every tire.
- Check the brakes for proper operation.

## **SMALL BICYCLE ACCESSORIES AND CHOKING HAZARD**

Some Bicycle accessories may present a choking hazard and other hazards to small children. Keep any bike parts, accessories and tools away from small children.

## **TECHNICAL SUPPORT**

It is important to your safety, performance, and enjoyment to understand how parts/components work on your bike. We urge you to ask EBC or a local EBC dealer how to fix the parts described in this section before you attempt to repair any parts yourself, and that you have EBC or your local EBC dealer check your work before you ride the bike. If you have even the slightest doubt as to whether you understand the instructions or precautions contained within this Manual, talk to EBC, your local EBC dealer or qualified mechanic- or do not ride your bike!

## **USING GOOD JUDGMENT**

Make sure no straps are dangling where they could get caught in the wheels – No bags, boxes or any items should be placed in a position where these items could get caught in the spokes. Please double check your load for security and stability. Check to see that your wheels are securely fastened and that no components or frame members are cracked or broken (in general, if at any time you notice a crack or bend in your bike, stem, forks, or bars of your bicycle, stop riding immediately; take your bike to EBC or your local EBC bike shop and have it inspected).

## WARNING: A SPECIAL NOTE TO PARENTS



As a parent or guardian, you are responsible for the safety of your adolescent when riding a bicycle.

To maximize the safe use of the bicycle by an adolescent, EBC strongly advises you to read this Manual in its entirety, and practice the following precautionary guidelines:<sup>1</sup>

- Understand and obey not only the applicable local motor vehicle, bicycle and traffic laws, but also adhere to common sense rules of safe and responsible bicycling.
- Make sure the bicycle is properly fitted to the adolescent.
- Make sure the bicycle is in good repair and safe to operate at all times.
- Make sure that you and your adolescent have learned and understand how to safely operate an electric bicycle and are familiar with the roads and/or other terrain upon which the bike will be ridden.
- Make sure your adolescent always wears an approved bicycle helmet when riding.<sup>2</sup>

Failure to follow warnings could result in serious injury or death.

---

<sup>1</sup> EBC assumes no liability for failure to comply with the stated guidelines.

<sup>2</sup> Make sure your adolescent understands that a bicycle helmet is for bicycling only and must be removed when not riding. A helmet should not be worn while playing in play areas, including playground equipment, etc.

## RIDING YOUR EBC BIKE/OPERATING PROCEDURES:

### CHARGING YOUR BATTERY

Our legacy Model C or S comes with an On-Board Charging System accessed by the pull-out ZIP CORD on the left side of the battery pack.



All other models (R, X, Y, E, F, A, and current model C & S) come with an external charger inside the white box marked "charger". Connect the power cord to the charger.

Plug the power cord into a 3-prong 110-volt outlet and the charging port of your charger to the charging port of your bike.



When the battery is charging you will hear the fan come on and the RED charging light will be on. When the battery is done charging the fan will turn off and the light will turn GREEN.

For models R, X, Y, E, F, A, and current C & S, simply unplug and store your charger in a safe, dry place once charging is complete. For legacy model C and S, after charging is

complete, unplug the cord from the wall and give the cord a quick tug pulling straight out from the battery pack a couple of inches and then release tension allowing the cord to retract into the battery pack.

Note: It is best to keep hanging on to the cord as it goes back into the battery pack to ensure it recoils smoothly and properly.



**WARNING RE GENERAL BATTERY CHARGING PRACTICES:** Only use a regular wall outlet to charge your EBC battery. Do not use any other type of outlet, such as an RV outlet or a converter or an inverter, or any other charger not recommended by EBC. Failure to comply with these instructions could lead to catastrophic consequences, including but not limited to battery malfunction, sparking, explosion or a battery fire. EBC is not responsible or liable for any damage caused by battery misuse and/or charging the battery in any other manner than per EBC instructions.

**WARNING RE Legacy C/S Battery:** DO NOT use an external charger to charge the legacy C/S battery using the small charging port located underneath the battery.



**WARNING RE Y Battery:** Only use the charging port located on the side of the basket to charge the battery and not the charging port located underneath the basket.



**Water damage is not covered under this warranty.**

**Battery Warranty:** EBC offers a 2 year warranty against manufacturer defects (see Warranty section), but if the consumer fails to charge the battery regularly and it goes dead overtime – the consumer will not be able to recharge him or herself. Consumers will either need to purchase a new battery or send the battery back to EBC for repair. Consumers can either drop off and pick up the battery for free or pay for shipment of the battery to be shipped to and from our location for repair. There is no repair cost or exchange cost to fix or exchange the battery within the first 30 days if malfunction is determined to be due to a manufacturer defect. After 30 days, battery repair cost will be waived if the consumer drops off battery or ships it back at his/her expense. A return label must be included. If a consumer opts to exchange the battery instead of having it repaired, the cost of an exchange is \$399 for a standard battery and \$499 for an upgraded battery. Consumers will receive a new battery and EBC will retain the old battery. Consumers are responsible for the shipping costs of a battery exchange. After 2 years, consumers will need to pay the full retail price of a new standard or upgraded battery.

**Failure to comply with these instructions could lead to catastrophic consequences, including but not limited to battery malfunction, sparking, explosion or a battery fire. EBC is not responsible or liable for any damage caused by charging the battery in any other manner than per EBC instructions.**

**BATTERY POSITION ON BIKE:**

To be able to use the electric motor, the battery must be mounted by sliding the fully charged battery forward into the battery holder. Depending on different models, the battery is located in different places.



Lock the battery when fully inserted in the battery holder. The battery must be locked when riding or it may fall out. The key does not have to be in to operate the bike.



For model C, S, X, A, and Y, your battery comes with a Master ON/OFF Switch. Depending on different models, the switch is located at different places. The Master switch must be turned on in order for the battery to operate. (NOTE: the Model R, E, and F do not include a master switch).

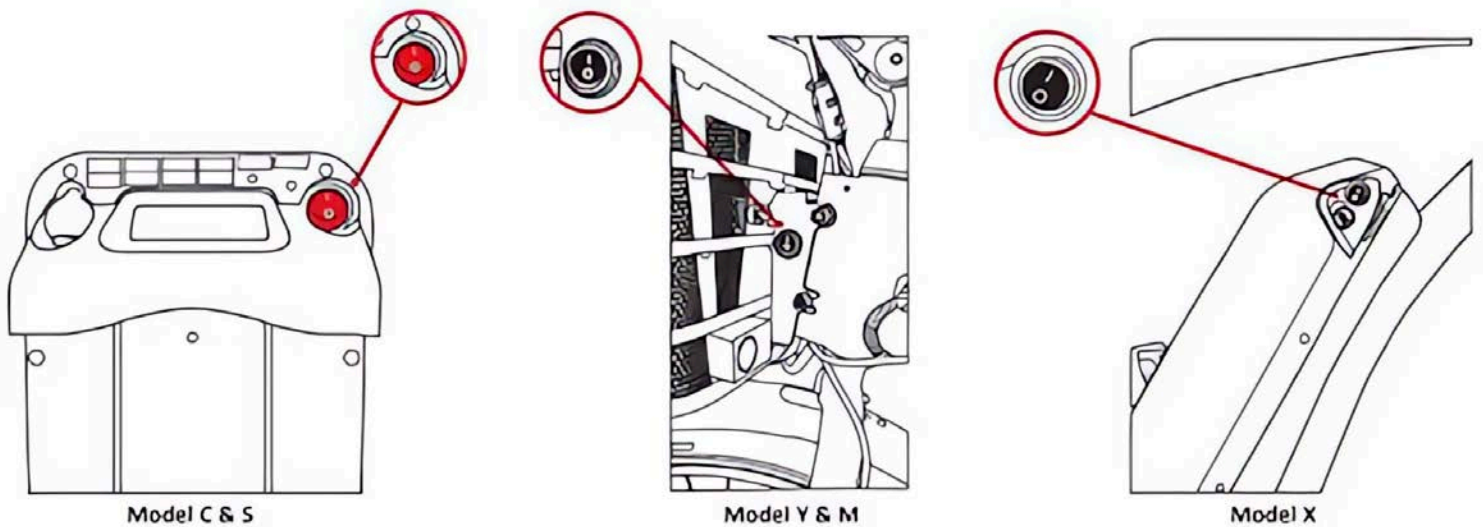

The switch is on when the “I” is depressed.

NOTE:

- If you are riding frequently, you can leave the switch in the ON position. When the bike is not being used for several days, it is best to turn the switch to the OFF or “O” depressed position.

- After 15 minutes of non-use, the battery management system "BMS" automatically turns off by itself for safety reasons and to save energy. To turn back on, toggle the master switch again.
- Be sure to turn the power switch off when the bicycle is not in use or is recharging by clicking the battery switch to the "O" position.
- Charging the battery while the bike or battery is in the on position can result in improper charging behavior or damage, including but not limited to battery malfunction, sparking, explosion, or a battery fire. Failure to follow this guideline voids the battery warranty. EBC is not responsible or liable for any damage caused by failing to adhere to this instruction.

## OPERATING YOUR BIKE THROUGH YOUR LCD DISPLAY

Your LCD Display is controlled through the LCD Control Button located on the left side of your handlebar. With the battery turned on, mount your bike, and press the middle ON/OFF button on the LCD Control with your left thumb until you see the screen display turn on.

### LCD Control Button



NOTE: It is always safest to mount the bike before turning on the display screen, as turning on the display screen enables the throttle. If you get on and off the bike with the display on, you could accidentally hit the throttle and send the bike forward. If this occurs, you will have better control of the bike if you are straddling the bike and holding onto the handlebars.

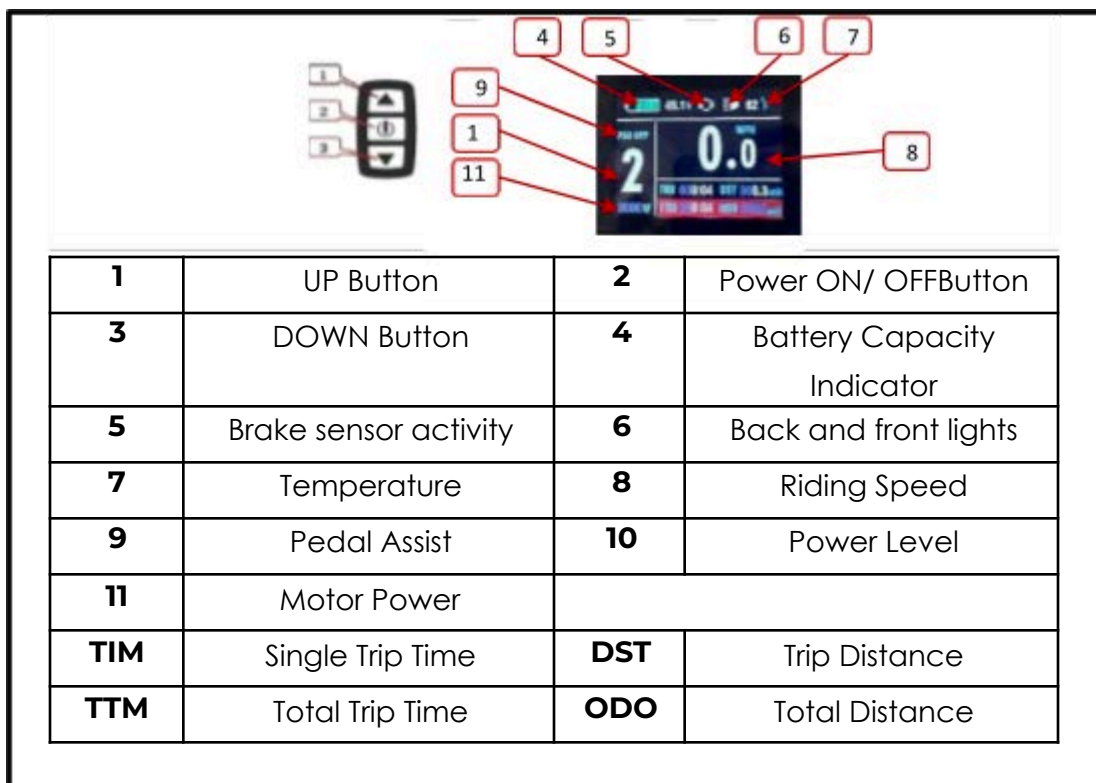

For advanced LCD programming and/or instructions on changing your settings, please refer to the LCD8 Manual which can be found on the EBC website under “User Manuals”.

NOTE: When you are finished riding, it is always safest to turn OFF the display, so you do not accidentally touch the throttle as you dismount.

## QUICK START GUIDELINES FOR USING PEDAL ASSIST

With the display ON you are ready to ride in THROTTLE mode. The throttle is now active and will power the motor. Pedal Assist mode is OFF.

To turn on the Pedal Assist Mode, press and hold the bottom DOWN ARROW on the LCD control for approximately three seconds until you see the word PAS OFF disappear from the left side of the display screen.

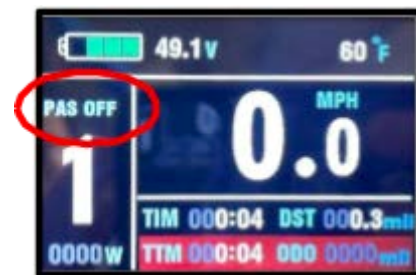



Using the UP and DOWN arrows you can set Pedal Assist from ZERO through 5 speed modes. One (1) is the slowest and Five (5) is the fastest.

With Pedal Assist mode ON, the motor will now turn on when you begin pedaling, and you will not need to use the throttle. You do have the ability, however, to increase your speed with throttle application while using Pedal Assist mode.

Note that it takes about two pedal rotations before Pedal Assist kicks in and turns on the motor.



**Important Note:** In the beginning, when you are getting used to the bike, it is always best to start out in PAS 1 or 2 mode and move up to the faster modes as you are riding. If you start out in the faster modes (3, 4 or 5), the motor is powerful and will go fast if you are not expecting it. In ZERO mode the pedal assist and the throttle are NOT active.

## ACTIVATING HEAD AND TAIL LIGHTS

To turn ON and OFF the head and taillights simply press and hold the UP arrow on the throttle mechanism for about three seconds until you see the display light up.

## BATTERY RANGE

### Tips:

- Know that riding your bike with full throttle or in “5 mode” in Pedal Assist will use up the battery more quickly than if you apply less throttle or ride in a lower pedal assist speed mode.
- If you are riding over 40 miles in one trip, use a lower pedal assist mode or pedal harder using throttle mode. This will assist the battery and extend your range by many miles.
- If you are on a long trip and the battery gets low and cuts off as you are riding, ease off on the throttle and it will come back on after a few seconds. If you ease off on the throttle or move down to pedal assist level 1, you will get a few more miles of riding out of the battery.
- Factors that Affect Range:

- State of your Battery Charge
- Mode Setting: the bike will use less power in pedal assist mode due to the required contribution of the rider
- Tire inflation pressure
- Adjustment of the wheel bearings and brakes: tight bearings or a dragging brake will adversely affect range
- Rider Weight
- The speed at which you travel, and local wind conditions.
- Terrain (road surface and hills): traveling on a soft surface, such as dirt or gravel, or climbing a hill uses energy faster
- Many starts and stops full power from a standing start draws the most amperage from the battery

### **How to Maximize Your Range:**

- Fully Charge your battery before each ride
- Ride in pedal assist mode and pedal as much as you feel comfortable doing – the more you pedal the further the battery will take you.
- Check your tire pressure regularly and inflate the tires to the maximum pressure printed on the tire sidewalls
- Have your bicycle serviced periodically to ensure that the bearings run freely and the brakes do not rub the rims (or the rotors for the disc brakes) when they are not applied
- Minimize the weight that you carry
- Ride at slower speeds
- Accelerate gently. Assist the system by pedaling as you accelerate to your cruising speed

**IMPORTANT NOTE:** As your battery ages, it will gradually lose capacity. With proper care and maintenance, your lithium-ion battery will retain up to 70% of its capacity for at least 500 discharge/recharge cycles. As capacity diminishes, you will notice a gradual drop off in max range capability. When range falls to an unacceptable level, contact your EBC dealer for information regarding purchasing a new battery.

## PEDAL ASSIST MODE – DETAILED INSTRUCTIONS FOR USE

Your Electric Bike Company bike LCD control screen monitors pedal assist, speed, odometer, trip distance, riding time, and battery energy level. To turn the LCD control screen on, make sure the battery is fully inserted and the on/off switch is turned on.

### LCD Screen Programming & Use

The LCD screen on your Electric Bike can be programmed to change various functions.

#### HOW TO PROGRAM THE EBC LCD BACK TO DEFAULT SETTINGS

- **Step 1:** Turn the Bike ON and immediately simultaneously depress the UP & DOWN Buttons for 3 seconds:



- **Step 2:** After the program screen comes up, click the ON/OFF button (middle) to start setting up.



**Note:**

- o When the number flashes, it's ready to set up.
- o **Increase:** UP Button      **Decrease:** DOWN Button
- o Click the ON/OFF button to finish and move to the next one.
- o C4 has 2 values.

- Standard Specification Values:

	MODEL C&S	MODEL X	MODEL Y&M	MODEL R
<b>LIM (MXS Speed)</b>	32	32	32	32
<b>DIM (Wheel Size)</b>	26	26	26	27.5
<b>UNIT</b>	3 (MHP/F)	3 (MHP/F)	3 (MHP/F)	3 (MHP/F)

<b>P1</b>	100	100	100	100
<b>P2</b>	1	1	1	1
<b>P3</b>	0	0	0	0
<b>P4</b>	0	0	0	0
<b>P5</b>	19	19	20	19
<b>C1</b>	6	6	6	6
<b>C2</b>	0	0	0	0
<b>C3</b>	1	1	1	1
<b>C4</b>	2 – 32	2 – 32	2-32	2-32
<b>C5</b>	6	2	7	7
<b>C6</b>	3	3	3	3
<b>C7</b>	0	0	0	0
<b>C8</b>	0	0	0	0
<b>C9</b>	0	0	0	0
<b>C10</b>	N	N	N	N
<b>C11</b>	0	0	0	0
<b>C12</b>	2	2	2	2
<b>C13</b>	0	0	0	0
<b>C14</b>	1	1	1	1
<b>L1</b>	0	0	0	0
<b>L2</b>	0	0	0	0
<b>L3</b>	1	1	1	1
<b>L4</b>	5	5	5	5

- **Step 4:** After complete set-up, HOLD ON/OFF Button for 3 seconds to finish.

Press together UP and Down Buttons located near the left grip on the handlebars for 3 seconds to turn the meter on. You can adjust the pedal assist power level to have more power by hitting the [+] button (third button) and can move to a lower-level power by hitting the [-] button.

If you set the pedal assist power level to the "0", then the pedal assist function of the bike is disengaged, and the bike can be powered by the throttle on the right grip. When first riding your Electric Bike Company, you will notice that when the pedal assist function is activated, the motor will supply power when you turn the pedals forward.

In pedal assist level 1, you will get assistance at around 40% of the maximum power from the motor. In level 5, you will get 100% assistance from the motor. Experiment with the different levels of pedal assist to become familiar with how much power you want. You will need different levels of pedal assist for different riding conditions.

When not riding the bike, you can turn off the meter by holding down the power button (top button) for several seconds.

Hold the "ON/OFF button" for 3 seconds to exit the setup interface.

To reset the previous trip, Turn the LCD ON and wait for 10 seconds, press UP and DOWN buttons together for 3 seconds. The order is: Trip Distance (TRIP), Riding time (TIME), and Odometer (ODO). Press the "ON/OFF button" to reset the trip information.

Press the power button (top button) once while the meter is on to turn on the backlight, as well as the integrated front and rear lights on the Electric Bike Company. Press and hold it for 3 seconds once more to turn the lights and backlight off.

Each LCD Meter comes with a USB port attached to the bottom of the meter to charge your mobile devices. To be able to get the power from the USB port, the LCD must be ON.

The bars are on an indicator that displays the amount of power that is being drawn from the battery. The more bars that are displayed, the more battery power is being used to power the e- bike.

After 5 minutes of inactivity, the LCD Meter will automatically turn off to conserve power.

## HAND THROTTLE CONTROL

When the pedal assist mode is set to "0", the pedal assist function does not engage, and the throttle will accelerate the bike forward. The throttle control is operated on the right-hand side. You control the throttle by pushing on the thumb attachment. The farther the throttle switch is from its resting position, the more power is delivered to the motor to accelerate the bike. When you want to slow down, simply release the throttle and let it return to its resting position and simultaneously apply the brakes. The e-bike also is equipped with a Throttle Override function, which allows the throttle to work in pedal assist modes.

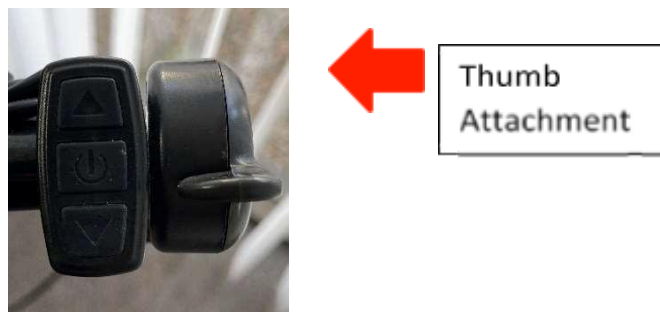

## BRAKES

Your Electric Bike is equipped with Hydraulic disc brakes for maximum reliability. Applying hand pressure to the brake levers will cause the wheel brake to create friction against the brake disc, slowing the wheel. The more hand pressure applied to the brake lever, the faster the e-bike will come to a stop.



Brake Lever



The rear brake should always be applied before and while the front brake is applied. Applying only the front brake to slow or stop at high speeds may result in the rider being ejected from the seat and continuing forward over the handlebars. It is best to apply even pressure to both brake levers when slowing or stopping. Bicycles equipped with disc brakes will occasionally make a slight scraping noise when the wheels are turning without the brakes being applied. This is normal.

Make sure that the brake lever does not contact the handlebar when full hand pressure is applied. If this occurs, the brakes must be adjusted by increasing the tension on the cable.

Hydraulic Brakes must be bled properly and by a certified bike mechanic – please service and maintain your brakes every 500 miles or every 6 months or whenever necessary. Brakes are a critical part of the bike, and it is essential that the front and rear brakes are working 100% of the time.



**Warning:**

- Disc brake rotors become hot during use. Do not touch or come in contact with the disc rotor shortly after use.
- Wet weather will require a longer distance to stop. Brake earlier and avoid sudden stops when riding in wet conditions.
- Riding On Hills:
  - o If you encounter a hill that causes the speed of your bicycle to drop below 7 miles per hour (11km/h) on electric power only (throttle mode) with the throttle fully applied, you should pedal to assist the bicycle up the hill.
  - o Failure to pedal can overstress the motor and controller, possibly causing those

components to overheat.

- Failure to pedal up steep hills to assist the bicycle also will overstress the battery, reducing its capacity and shortening its useful life.
- Riding In Adverse Weather Conditions:
  - Your electric bike is built with components that are sealed against dust and water and can safely operate in most weather conditions. To ensure the longest life of your components, however, you should avoid riding in wet weather when possible.
  - The EBC battery, however, **cannot** handle heavy raining conditions. You should refrain from using the bicycle in heavy or long-lasting rain (more than 3-4 minutes).
- Never charge or use the 12v outlet after riding in the rain. Park the bike in a dry, warm place and wait at least 24 hours before charging or using the 12V port.
- Since Electric Bikes are faster and heavier than normal bikes, when riding in wet weather, you should use extreme caution. You are more likely to fall from a wet road surface when traveling at high speed. Heavy electric bikes also take longer to slow down and the required stopping distance in wet weather is even greater. Be sure to leave ample room for stopping and brake gently and evenly to avoid falling.

## **ELECTRIC BIKE SERVICE AND MAINTENANCE GUIDELINES**

### **SERVICE**

Your bike needs to be checked and serviced by a qualified bike mechanic with every 500 miles of riding. This is a standard “best practice” for any new bike, as cables will stretch, and components will “bed in”. The service must include spoke tensioning for both front and rear wheels.

- If you have any questions, issues, or concerns please call the ELECTRIC BIKE COMPANY at (949) 264-4080.
- Do not ride a bike you suspect may not be functioning fully.
- Please refer to our website for additional information: [www.electricbikecompany.com](http://www.electricbikecompany.com)
- DO NOT ATTEMPT TO DISASSEMBLE OR ADJUST ANY OF THESE COMPONENTS: the motor, motor controller, battery, battery charger, throttle, or wiring harness of your electric bicycle. Doing so may cause extensive damage to these components, will void your



warranty, and may cause a hazardous condition. If you cannot resolve a problem, contact EBC or your local EBC dealer.

- Technological advances have made bicycles and bicycle components more complex, and the pace of innovation is increasing. It is impossible for this manual to provide all the information required to properly repair and/or maintain your bicycle. In order to help minimize the chances of an accident and possible injury, it is critical that you have any repair or maintenance, which is not specially described in this manual performed by EBC or by your local EBC dealer.

Your individual maintenance requirements will be determined by everything from your riding style to geographic location. Consult EBC or your local EBC dealer for help in determining your maintenance requirements.

Many Bicycle service and repair tasks require special knowledge and tools. Do not begin any adjustments or service on your bicycle until you have learned from EBC or your local EBC dealer how to properly complete them. Improper adjustment or service may result in damage to the bicycle or in an accident, which can cause serious injury or death.

Before performing ANY service, inspection, or maintenance on your electric bicycle, you should first remove the battery. Failure to remove the battery could lead to the bicycle turning on unexpectedly, causing serious damage and injury.

If you have to perform maintenance that requires the battery to be installed, you must be sure that even if the bicycle wheel, chain or other drivetrain components begin moving unexpectedly they will not be in a position to cause injury or damage.

If you want to learn to do major service and repair work on your bike:

- Ask EBC or your local EBC dealer for copies of the manufacturer's installation and service instructions for the components on your bike, or contact the component manufacturers. Ask your dealer to recommend a book on bicycle repair.
- Ask your dealer about the availability of bicycle courses in your area.
- We recommend that you ask EBC or your local EBC dealer to check the quality of your work the first time you work on something and before you ride the bike, just to make sure that you did everything correctly. Since that will require the time of a mechanic, there may be a service charge.
- We also recommend that you ask EBC or your local EBC dealer for guidance on what the spare parts, such as inner tubes, lights bulbs, etc. would be appropriate for you to

have once you have learned how to replace such parts.

- Also follow our official Electric Bike Company YouTube channel at <https://www.youtube.com/channel/UC7WNRi1Oi5iUeQyblgTI8ZA> for all helpful videos

## TORQUE SPECIFICATIONS

Correct tightening of the torque of threaded fasteners is very important to your safety. Always tighten fasteners to the correct torque.

Bolts that are too tight can stretch and deform. Bolts that are too loose can move and fatigue. Either mistake can lead to a sudden failure of the bolt – or the connection.

Always use a correctly calibrated torque wrench to tighten critical fasteners on your bike. Carefully follow the torque wrench manufacturers instruction on the correct way to set and use the torque wrench for accurate results.

In case of a conflict between the instructions in this manual and information provided by a components manufacturer, consult with EBC or your local EBC dealer or the manufacturer's customer service representative. But do not ride your bike until you are comfortable and verify the information.

<u>FASTENER TORQUE SPECIFICATIONS</u>		
<u>Component</u>	IN- LB	NM
<b>Headset, Handlebar, Seat area</b>		
Seat fixing bolt (reg. seat post, others hare spec on post)	177-248	20-28
Stem handle binder bolts	124	14
Stem Wedge (binder) bolts - quill type for threaded headset	195	22
Threaded headset locknut	204	23
Thread less Stem Clamp bolts	106-115	12-13
<b>Crankset, Bottom Bracket, Pedal Area</b>		
Chainring bolt (aluminum)	124	14
Chainring Bolt (steel)	354	40
Crank Bolt	305-391	34.5-44.2
Pedal (into crank)	307-350	34.7-39.5
<b>Derailleur, Shift Lever area</b>		

Rear Derailleur Cable Pinch Bolt	35-45	4.0-5.1
Rear Derailleur Mount Bolt	70-86	7.9.-9.7
Shift Level (MTB thumb-type)	22-26	2.5-2.9
<b>Rack Area</b>		
Bicycle Rack to Frame	88.5	10
<b>Wheel Area</b>		
Wheel Axle Nuts to Frame	266-310	30-35
<b>Brakes</b>		
Brake Caliper to Frame/Fork	62	7.0
Brake Lever to Handlebar	53	6.0
Brake pad to caliper	18-27	2.0-3.0
Disc Rotor to Hub	35-55	4.0-6.2

## MAINTENANCE

- Some service and maintenance can and should be performed by the owner and require no special tools or knowledge beyond what is presented in this manual.
- You should have your bicycle and its components checked periodically by EBC or your local EBC dealer for indicators of stress and/or potential failure, including cracks, deformation, corrosion, paint peeling, dents and any other indicators of potential problems, inappropriate use or abuse. These are important safety/maintenance checks and very important to help prevent accidents, bodily injury to the rider and shortened product life.
- The following are examples of the type of service you should perform yourself:<sup>3</sup>
- Break In Period: Your bike will last longer and perform more efficiently if you break it in before riding it hard. Control cables and wheel spokes may stretch when a new bike is

---

<sup>3</sup> A qualified bicycle mechanic using the correct tools and procedures specified by the manufacturer should perform all other service, maintenance and repair in a properly equipped facility.

first used and may require readjustment by your dealer. Your Mechanical Safety Check (below) will help you identify some things that need readjustment.

- Even if everything on your bike seems to be in working order, it is best to take your bike back to EBC or to your local EBC dealer periodically for check-ups. We typically suggest you bring your bike in for a 6 months – 1 year check-up.
- Another way to judge when it is time for the first check-up is to bring the bike in after three to five hours on the road. Of course, if at any time you suspect something is wrong with the bike, take it to EBC or to your local EBC dealer for a check-up prior to riding it again.
- Mechanical Safety Check – Perform the following maintenance after every long or hard ride, and especially if the bike has been exposed to water or grit; or at least every 500 miles:
  - o Clean the bike (consult the drive system manufacturer's user manual for specific cleaning instructions or warnings). Lightly lubricate the chain rollers with a good quality bicycle lubricant. Wipe off excess lubricant with a lint-free cloth. Lubrication is a function of climate. Talk to EBC or to your local EBC dealer about the best lubricants and the recommended lubrication frequency for your area.
  - o Squeeze the front brake and rock the bike forward and back. Make sure everything feels solid. If you feel a clunk with any forward or backward movement of the bike, you probably have a loose headset. Have your bike checked by your dealer. If either brake lever fails, don't ride the bike. Have EBC or your local EBC dealer check and repair or replace.
  - o Lift the front wheel off the ground and swing side to side. If you feel any binding or roughness in the steering, you may have a tight headset.
  - o Rock one of the pedals toward and away from the centerline of the bike; then do the same with the other pedal. If anything feels loose, have your dealer check it.
  - o Examine the brake pads. If they are starting to look worn or not hitting the wheel rim squarely, have the dealer adjust or replace them.
  - o Check the control cables and cable housing. If you observe any kinks or fraying, have your dealer replace them.

- Squeeze each adjoining pair of spokes on either side of each wheel between your thumb and index finger. They should feel the same. If any spokes feel loose, have your dealer check the wheel for tension and trueness.
- Check the tires for excess wear, cuts or tears. If you are unsure whether your tires are worn or damaged, ask your dealer, who can replace them if necessary.
- Check the wheel rims for excess wear, dings, dents and scratches. Consult your dealer if you see any rim damage.
- Check to make sure that all parts and accessories are still secured and tighten any which are not.
- Check the frame, particularly in the area around all tube joints, the handlebars, the stem, and the seat post for any deep scratches, cracks or discoloration. There are signs of stress-caused fatigue and indicate that a part is at the end of its useful life and needs to be replaced. See also "The lifespan of your bike and its components."
- If the chain won't shift smoothly and quietly from gear to gear, the derailleur is out of adjustment, and you consult EBC or your local EBC dealer.

## BIKE RIDING - GENERAL SAFETY

Riding any bicycle, including electric bikes, carries certain risks and caution must always be exercised. The following is a list of general bicycle safety rules and best practices that you should always comply with in order to maximize the safety of your ride:

1. Obey the Rules of the Road and all traffic Laws.
2. Remember that you are sharing the road or path with others – motorists, pedestrians and other cyclists. Respect their rights.
3. Ride defensively. Always assume that others do not see you.
4. Look ahead, and be ready to avoid the following:
  - Vehicles slowing or turning, entering the road or lane ahead of you, or coming behind you.
  - Parked car doors opening
  - Pedestrians stepping onto the road or path
  - Children or pets playing near the road
  - Potholes, sewer grating, railroad tracks, expansion joints, road or sidewalk construction, debris and other obstructions that could cause you to swerve into traffic, catch your wheel or cause you to have an accident
  - Miscellaneous other hazards and distractions which can occur on a bicycle ride
5. Ride in the designated bike lane, on designated bike paths or as close to the edge of the road as possible, in the direction of traffic flow or as directed by the local governing law.
6. Stop at all stop signs and traffic lights, slow down and look both ways at intersections. Remember that a bicycle always loses in a collision with a motor vehicle, so be prepared to yield even if you have the right of way.
7. Use approved hand signals for turning and stopping.

8. Wear proper attire, including bright clothing, protective glasses, and sturdy shoes. Never wear a loose-fitting dress or long dress when riding – it can get caught in the moving parts of the bike and cause serious injury or even death.
9. Never ride with headphones. They mask traffic sounds and emergency vehicle sirens, distract you from concentrating on what is going on around you, and their wires can tangle in the moving parts of the bicycle, causing you to lose control.
10. Never carry a passenger, unless it is a small child weighing less than 40 pounds whom you feel comfortable carrying on a bike, can maintain head control and absorb the stresses felt on a bike ride. Ensure the child is wearing an approved helmet, appropriate clothing for the ride and is secured in a correctly mounted child carrier or a child carrier trailer. Any child seat that is attached to an EBC bike is for sidewalk and boardwalk riding only and should never be used on the open road where there is a chance of contact with a car or other moving vehicles. Never exceed 15 miles per hour when you are carrying a child on a rear rack child carrier, or 20 miles per hour when transporting a child in a child trailer.<sup>4</sup>
11. Never carry anything that obstructs your vision or your complete control of the bicycle, or which could become entangled in the moving parts of the bike.
12. Never hitch a ride by holding on to another vehicle or bike.
13. Do not weave through traffic or make any moves that may surprise people with whom you are sharing the road.
14. Observe the right of way.
15. Avoid riding in bad weather, when visibility is obscured, at dawn, dusk or in the dark, or

---

<sup>4</sup> Check the drive system manufacturer's manual, or other system manual included with your bike, for warnings regarding trailer usage.



when extremely tired. Each of these conditions increases the risk of accident.

16. Always bring some form of identification when riding.
17. Yield right of way to pedestrians and animals.
18. Signal with voice or bell when passing.
19. Walk your bike up or down access ramps or whenever you feel uneasy, unsure or unsafe.
20. Maintain a minimum of 10 feet behind the bike in front of you.
21. Be aware that your extra speed, and extra weight of the bike mean you must be more careful, especially around other trail users. Wet weather impairs traction, braking and visibility, both for the bicyclist and for other vehicles sharing the road. The risk of an accident is dramatically increased in wet conditions.
22. Wet weather may lessen the grip of the rider's feet on the pedals. If your feet slip off the pedals, it could lead you to fall.
23. Night Riding – Riding your bike at night is much more dangerous than riding during the day. Adolescents or inexperienced bike riders should never ride at dawn, at dusk or at night. Adults who choose to accept the increased risk of riding at these times need to take extra care both riding and choosing specialized equipment, which can help to reduce that risk. When riding at night or in other hazardous conditions – RIDE SLOWLY – no more than 10 miles per hour.
24. Consult your local authorized bike shop or dealer about night riding and safety equipment.
25. Reflectors are not a substitute for required lights. Riding at dawn, at dusk or at night or at other times of poor visibility without adequate bicycle lighting systems and without

reflectors is dangerous and may result in serious injury.

26. Check reflectors and their mounting brackets regularly to make sure that they are clean, straight, unbroken, and securely mounted. Have EBC or your local EBC dealer replace damaged reflectors and straighten or tighten any that are bent or loose.
27. Do not remove the front or rear reflectors or reflector brackets from your bike. They are an integral part of the bicycle safety system. Removing the reflectors reduces your visibility to others using the roadway.
28. Make sure your bicycle has and always is equipped with correctly positioned and securely mounted reflectors.

# ADDITIONAL SAFETY MEASURES FOR RIDING ELECTRIC BIKES

Because electric bikes are faster and heavier than normal bicycles, they require extra caution and care while riding. Failure to heed the following safety instructions could lead to a crash, injury, or death.

1. ALWAYS wear a helmet, closed toe shoes and eye protection when riding.
2. Electric bikes are considerably heavier than normal bicycles. For this reason, parking, pushing, lifting and carrying the bike is more difficult. Bear this in mind when loading your bike into a car and unloading it, or when mounting into a bicycle carrier system.
3. Never ride at a speed outside your comfort zone, or that you feel may be unsafe for the given conditions.
4. When mounting your bike, make sure not to step on the pedals until you are sitting on the saddle and gripping the handlebars firmly.
5. Keep your hands on the brake levers – or at least two fingers and remember that they will always slow or stop the bike if pulled.
6. Get used to riding your EBC bike without power or use of throttle or PAS (peddle assist) – only once you are comfortable riding the bike as a regular bike then slowly introduce the PAS on lowest level and work your way up. After you are 100% comfortable with PAS then start using the throttle – very gently at first until you are comfortable with the settings, speed and acceleration.
7. When you're ready to introduce power, use the lowest assist setting until you feel confident controlling the electric assist.
8. Heavy electric bikes take longer to slow down; leave extra space for stopping safely.

Remember that all the information in this manual referring to bicycle safety also applies to your electric bike.

# CHECKLIST: BEFORE YOU RIDE YOUR EBC BIKE

## Important Information about Your Bike Components and Accessories

In order to ensure maximum safety, the following is a description of the exercises you should go through prior to riding your EBC bike. This section will also describe the various components to your EBC bike, including their proper use and maintenance.

When you buckle on your helmet and go for your first ride, be sure to pick an area away from cars, other cyclists, obstacles or other hazards in order to become familiar with the controls, features and performance of your new Electric Bike.

## PART I: Introduction to and Safe Use of Your Non-Electric Components

### Brake Check:

- Ensure both brakes work prior to going on every single ride.
- Familiarize yourself with the braking actions of the bike. Test the brakes at slow speed, putting your weight towards the rear and gently applying the brakes, rear brake first.
- Check the quick releases are closed. Check all control cables are seated and securely engaged.
- Sudden or excessive application of the front brake could pitch you over the handlebars. Applying brakes too hard can result in locking up the wheel, which could cause a loss of control and injuries. Skidding is an example of what can happen when a wheel locks up
- Ensure you can fully engage the brakes without them having touch the handlebars
- Do not ride the bike unless the brakes are working well and adjusted by a professional bike mechanic.

### Disc Brakes:

- Riding with improperly adjusted brakes, worn brake pads, or wheels on which the rim ware marks are visible, is dangerous and can result in serious injury or death
- Your EBC Bike is fitted with disc brakes. Disc brakes are extremely powerful. Take

extra care in becoming familiar with the brakes.

- Exercise care in touching the rotator or the calipers. Disc rotors have sharp edges, and both rotors and calipers can get VERY hot.
- Your EBC bike is equipped with Hydraulic Disc brakes – to maintain the warranty and safety of the bike, a qualified mechanic or dealer must repair, replace and maintain your brakes. Please ensure you take your bike to your dealer at least every 500 miles or when you observe that your brakes are weak, scraping or generally not working well.
- Be careful not to damage the rotor, calipers or brake pads when re-inserting the rotor into the caliper. Never activate a disc brake's control lever unless the rotor is correctly inserted in the caliper.
- See the brake manufacturer's instructions for operation and care of your brakes, and to determine when brake pads must be replaced. If you do not have the manufacturer's instructions, contact EBC, your local EBCF dealer or the brake manufacturer directly.
- If replacing worn or damaged parts, use only manufacturer's approved genuine replacement parts.

### **Brake Controls and Features:**

- For your safety you should know which brake lever controls the front and which controls the rear brake on your bike. Typically, the right brake lever controls the rear brake, and the left lever controls the front brake. To confirm, squeeze one brake lever and look to see which brake (front or rear) engages. Next, do the same with the other brake lever.
- Make sure your hands can reach and squeeze the brake levers comfortably. The lever reach is adjustable. If you are unable to reach the brakes, you may need a different brake lever design.
- If at any time, for any reason, you need to stop the bike or stop the bike motor from turning – simply squeeze the brake levers.

### **Shifting Gears:**

- Practice shifting gears in a safe place, away from vehicles or other hazardous

environments, until you feel comfortable with your ability to control your bicycle speed.

- Never move the shifter while pedaling backwards. This could jam the chain and cause serious damage.

### **Tire and Wheel Safety:**

- Ensure both front and back wheels are securely fastened – and if you do not know how or what this is – do not guess – take the entire bike to an authorized certified bike mechanic. Incorrect install or replacement of wheels, tires, brakes, cables or any part of the bike can cause serious injury or even death!
- Make sure tires are correctly inflated. Check by putting one hand on the saddle, one on the intersection of the handlebars and stem, then bouncing your weight on the bike while looking at the tire deflation. Compare what you see with how it looks when you know the tires are correctly inflated; and adjust if necessary.
- Check to see if tires are in good shape – Spin each wheel slowly and look for cuts in the tread and sidewall. REPLACE damaged tires before riding your bike.

**WARNING** - Bicycle Rims are subject to wear. Ask your mechanic to check the usability of your RIMS and keep this in mind in making your decision to ride your bike – constantly check this with your qualified mechanic.

- Ensure your wheels are TRUED before each ride. Spin each wheel and check for brake clearance and side to side wobble. If a wheel wobbles side to side even slightly or rubs against or hits the brake pads, take the bike to a qualified bike shop to have the wheel trued.
- Bicycle Wheels are designed to be removable for easier transportation and for repair of a tire puncture. In most cases, the wheel axles are inserted into slots, called “dropouts” in the fork and frame. EBC bikes have two ways of securing the wheels – front wheels are secured using the hollow axle with a shaft (“skewer”) running through it which has an adjustable tension nut on one end and an over –center cam on the other. The back wheel uses a Hex nut and hex key bolts which are threaded onto the hub axle.
- It is very important that you understand the type of wheel securing method on your bike, that you know how to secure the wheels correctly, that you know how to apply

the correct clamping force that safely secures the wheel. Ask a bike mechanic to instruct you in correct wheel removal and installation and ask him to give you any available manufacturers instruction.

- Riding with an improperly secured wheel can allow the wheel to wobble or fall off the bike, which can cause serious injury or death. Therefore, it is essential that you
  - o Ask EBC or your local EBC dealer to help you make sure you know how to install and remove your wheel safely.
  - o Understand and apply the correct technique for clamping your wheel in place.
  - o Each time, before you ride the bike, check that the wheel is securely clamped. The clamping action of a correctly secured wheel must emboss the surfaces of the drop out.
  - o Front wheel Secondary Retention Devices:
    - EBC bikes have front forks, which utilize a secondary wheel retention device to reduce the risk of the wheel disengaging from the fork if the wheel is incorrectly secured. Secondary retention devices are not a substitute for correctly securing your front wheel.
    - Failure to properly secure the wheel can cause the wheel to wobble or disengage, which could cause you to lose control and fall, resulting in serious injury or death.
  - o Tire Inflation and Deflation:
    - Never inflate a tire beyond the maximum pressure marked on the tires sidewall. Exceeding the recommended pressure may blow the tire off the rim which could cause damage to the bike and serious or fatal injury to the rider and injury to bystanders.
    - There is a safety risk in using gas station air hoses or other compressors. They are not made for bicycles. They move a large volume of air into your tire very rapidly, which could cause the tube to explode. You should only use a bicycle pump which has a built-in pressure gauge.
    - To minimize tire wear and for maximum riding safety, comfort, and handling, maintain recommended tire air pressure, which can be found



on the side wall of all tires. Use a reliable tire air pressure gauge to check for proper inflation before every ride. At the same time, inspect tires for excessive wear and cracks. Replace tires if necessary.

o Inner Tube of Tire:

- We highly recommend that you carry a spare inner tube when you ride your bike. Although EBC inner tubes are puncture resistant, they are not 100% puncture proof. The tubes provide significant protection for up to 3mm holes, but you should always be prepared for unforeseen punctures. Have an authorized mobile mechanic's number handy – and request their assistance in the event of a tire puncture.
- Patching: Always carry a patch kit so that you can patch a tube in an emergency repair. Caution: If you do not apply the patch correctly or apply several patches, the tube can fail, which could cause you to lose control and fall. Replace a patched tube as soon as possible.

### **Bike Fit:**

Follow the instructions below to ensure your e-bike is the appropriate fit for you. If the e-bike is not the appropriate fit for height/stature, do not ride it. Maximum weight of an EBC rider = 300lbs.

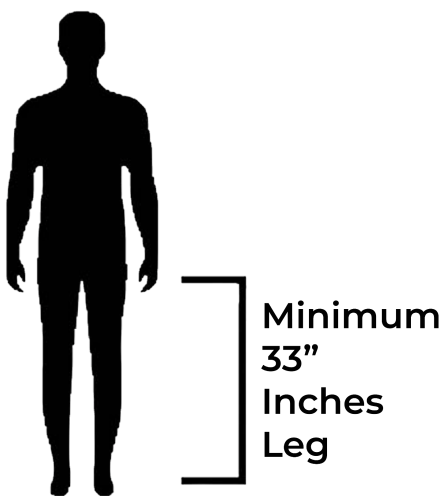

1. Stand with your back against a wall.
2. Spread your feet 6-8" apart on a hard, smooth surface.
3. Place a book (Approx. 3" Width) between your legs and up against the wall, spine up; raise it until snug against your crotch (this mimics your bike seat).
4. Have another person measure from the top of the book (spine) down to the floor.

## Proper Frame Fit:



(For models with a top tube)

Rider must be able to straddle the bicycle with at least 1 inch (25.4mm) clearance above the top tube standing as illustrated.

## Stem, Handlebars, Ends and Grips:

- Ensure that the stem and handlebars are properly fastened. Also look for any cracks or fatigue.
- Alignment – make sure the saddle and handle stem are parallel to the bike's center line and clamped tight enough so that you can't twist them out of alignment. If you observe any issues with alignment, you must have the bike inspected by a qualified bike mechanic prior to riding.
- Loose or damaged handlebar grips or extensions can cause you to lose control and fall. Unplugged handlebars or extensions can cut you and cause serious injury. Make sure the handlebar grips are secure and in good condition. If not, have your dealer replace them.
- Make sure the handlebar ends and extensions are plugged. If not, have your dealer plug them.
- Make sure the grips are tight enough that they do not twist.
- To adjust the handlebar, use the right size Alan key to adjust the height. See the Quick Start Guide instructions for additional details. Never adjust above the recommended mark, or high enough to allow 4 inches of the stem to be left inside the head tube.
- It is critical to tighten the Alan Key bolt according to the torque table.
- Always check that the stem is tight and cannot move.
- If the stem is extended beyond the minimum insertion mark the stem may break or damage the fork's steerer tube, which could cause you to lose control and fall.

- On some bicycles, changing the stem or stem height can affect the tension of the front brake cable, locking the front brake or creating excess cable slack which can make the front brake inoperable. IF the front brake pads move in towards the wheel rim or out away from the wheel rim when the stem or stem height is changed, the brakes must be correctly adjusted before you ride the bicycle.
- Stem angle: Our Bikes are equipped with an adjustable angle stem. Ask EBC or your local EBC dealer to show you how to adjust it. Do not attempt to make the adjustment yourself as changing the stem angle may also require adjustments to the bike's control. See the Quick Start Guide.

**WARNING:** An insufficiently tightened stem clamp bolt, handle clamp bolt or bar end extension clamping bolt may compromise steering action, which could cause you to lose control and fall. To determine whether the stem of your bike is tightened properly, place the front wheel of the bicycle between your legs and attempt to twist the handlebars/stem assembly. If you are able to twist the stem in relation to the front wheel or turn the handlebars in relation to the stem or turn the bar end extension in relation to the handlebars, the bolts are insufficiently tightened.

EBC, a bike mechanic or a local EBC dealer may be consulted to set up your bike and ensure all bolts are tightened properly.

Thereafter it is your responsibility to check the clamp bolt each time you ride.

- Control Position Adjustments: The angle of the brake and shift control levers and their position on the handlebars can be changed. Ask your dealer to make the adjustments for you. If you choose to make your own control lever adjustment, be sure to re-tighten the clamp fasteners to the recommended torque.
- Brake Reach:
  - o This EBC bike has brake levers that have adjustments for tension and reach. If you have small hands or find it difficult to reach the levers – ask your dealer to adjust the levers, change the brake lever or do not ride the bike.
  - o The shorter the brake lever reach, the more critical it is to have correctly adjusted brakes, so that full braking power can be applied within available brake lever travel. Brake lever travel that is insufficient to apply full braking power can result in loss of control, which can result in serious injury or death.

## **Bolts and Nuts:**

- Check the condition of the bolts and nuts on your bike before EVERY RIDE – bolts and nuts will come loose, so it is important to check the appropriate attachment of every nut and bolt.
- Correct tightening force on fasteners, nuts, bolts, and screws is extremely IMPORTANT – too little force, and the fastener may not hold securely. Too much force, and the fastener can strip threads, stretch, deform, weaken, or break. Either way, incorrect tightening force can result in component failure immediately or anytime in the future, which can cause you to lose control, fall or worse, lead to serious injury or even death.
- To confirm that no component parts are loose, lift the front wheel off the ground by two or three inches, then let it bounce on the ground. Ensure nothing sounds, feels or looks loose.
- Do a visual and tactical inspection of the whole bike. Any loose parts or accessories need to be secured and checked by a qualified approved mechanic.
- To ensure that the many fasteners on your bicycle are correctly tightened, refer to the table showing “Fastening Torque Specifications”.
- Correctly tightening a fastener requires a calibrated torque wrench. A professional bicycle mechanic with a torque wrench should torque the fasteners on your bike.
- If you need to make an adjustment at home or in the field, we urge you to exercise care, and to have the fasteners you worked on checked by EBC, your local EBC dealer or a qualified mechanic before your next ride.

## **Saddle:**

- Saddle Position:
  - o Correct saddle adjustment is an important factor in getting the most performance and comfort and safety from your bike.
  - o Ask EBC, your local EBC dealer (or qualified bike mechanic) to set the saddle for your optimal riding position and to show you how to make this adjustment. If you choose to make your own saddle height adjustment, you should go through the following steps:

- Loosen the seat clamp.
  - Raise or lower the seat post in the seat tube (ensure the sleeve is all the way down and snug inside the seat tube).
  - Make sure the saddle is straight fore and aft.
  - Make sure the sleeve is all the way down and snug and level with the top of the seat tube.
  - Re-tighten the seat post clamp to the recommended torque. Please refer to the torque table or manufacturers' instructions or get advice from EBC, your local EBC dealer or a qualified mechanic).
  - Once the saddle is at the correct height, make sure that the seat post does not project from the frame beyond its "minimum insertion" or "Maximum extension mark" or no more than 4 inches from the lowest point above the end of the seat tube.
  - When making saddle angle adjustments with a single bolt saddle clamp, always check to make sure that the serrations on the mating surfaces of the clamp are not worn. Worn serrations on the clamp can allow the saddle to move, causing you to lose control and fall.
- Always tighten fasteners to the correct torque. Bolts that are too tight can stretch and deform. Bolts that are too loose can move and fatigue. Either mistake can lead to a sudden failure of the bolt, causing you to lose control and fall.

NOTE: If your bike is equipped with a suspension seat post, the suspension mechanism may require periodic service and maintenance. Ask your dealer for recommended service intervals for your suspension seat post.
  - Small changes in the saddle position can have a substantial effect on performance and comfort. To find your best saddle position, make only one adjustment at a time.
  - After any saddle adjustment, be sure that the saddle adjustment mechanism is properly seated and tightened before riding. A loose saddle clamp can cause damage to the seat post or can cause you to lose control and fall. A correctly

tightened saddle adjusting mechanism will allow no saddle movement in any direction. Periodically check to make sure that the saddle adjusting mechanism is



properly tightened.

- Some people have claimed that extended riding with a saddle which is incorrectly adjusted, or which does not support your pelvic area correctly can cause short term or long-term injury to nerves and blood vessels, or even impotence. If your saddle causes you pain, numbness, or other discomfort, listen to your body and stop riding until you see your dealer about the saddle adjustment or a different saddle.

## **Pedals**

- Ensure your pedals are tightened according to the torque chart – and ensure they have reflectors on either side. Never allow your foot to hit the front wheel while it rests on the pedal.
- Never use clips in shoes, slaps, or toe clips on EBC bikes.

## **Kickstand**

- The "side-stand" style kickstand has a single leg that tips out to one side and allows the bike to lean against it.

## **Keys**

- The keys are used to lock the battery into place. Always make sure that the key position is in the "open" setting when removing or inserting the battery.
- Move the key to the "lock" position to secure the battery before operating the bike. Riding the bike with the key in the "open" position risks allowing the battery to slide out and damage the battery when dropped.
- Always remove the battery from the bike when transporting on a bike rack.

## **General**

- Check out the handling and responsiveness of the bike. If you have any questions or

feel the bike is not performing properly, consult EBC, your local EBC dealer or a qualified bike mechanic.

## **PART II: Introduction to and Safe Use of Your Electric Components**



**WARNING:** At no time should you make any modifications to your bikes' electrical systems unless they are explicitly approved by the manufacturer in writing.

### **Motor:**

- EBC bikes are equipped with a high torque 500W geared hub motor. The motor sits in the middle of the rear wheel. The motor's axil is held fixed in the rear drop out and its shell is spun by internal electronics. The rotation of the hub is independent of any bicycle drivetrain components, including the cranks, derailleur or cassette

### **Pedal Assist Sensor ("PAS"):**

- EBC bikes are equipped with a Pedal Assist Sensor, which is installed on the bottom bracket, and senses pedal crank rotation electronically.

### **Throttle:**

- EBC bikes are equipped with a thumb throttle, which is located on the right side of the handlebar. Like on a motorcycle, a bike throttle is designed to let the user apply 0-100% of the motor's power at will. The throttle can act independently or in tandem with or without PAS.

### **Brake Disconnect Switch:**

- EBC Bike brakes include an electronic disconnect switch which is activated when the lever is depressed. Depressing this switch will disconnect the power to the motor.
- You should check the operation of your brake disconnect switch before every ride: While riding slowly in a controlled environment (like your driveway), engage the motor then squeeze each brake separately. The motor should lose power

immediately and remain off as long as a brake lever is depressed.

**Caution:** The cable of your disconnect-switch can be cut, come loose or malfunction – so always perform a check before you ride. Be sure to depress both brakes in an emergency or when you need the motor to disengage.

### **Battery: Important Safety Warnings**

- Our EBC batteries are of the highest quality. They are equipped with Smart Chargers and Smart BMS (battery management system) to ensure the battery will last as long as possible. You can expect your EBC battery to last at least 3 years, but closer to 5-8 years, depending on extent of use.

#### **WARNING:**

- o Failure to properly use, charge, and store your battery as instructed will void the warranty and could cause a hazardous situation. Before using your battery for the first time, read this section of the manual in its entirety.
- o **Use a regular wall outlet to charge your battery. Do not use any other type of outlet, such as an RV outlet or a converter or an inverter, or any other charger not recommended by EBC.** For more Battery charging information and instructions, see the “Charging Your Battery” section of this manual.
- o Failure to comply with these instructions could lead to catastrophic consequences, including but not limited to battery malfunction, sparking, explosion or a battery fire. EBC is not responsible or liable for any damage caused by battery misuse and/or charging the battery in any other manner than per EBC instructions.
- o If you have any questions about your EBC battery or its usage, please contact a member of our EBC Team at (949) 264-4080 for additional instructions and guidance.

#### **What To Do When You First Purchase Your New EBC battery:**

- o Batteries are not shipped with a full charge. You should charge your battery for at least 4-5 hours with a super external charger or for at least 10 hours with the



internal charger.

- EBC batteries are equipped with a five-minute sleep function. If no activity is detected, the bike will go into “stasis” mode to conserve battery power. Simply cycle the bike off then on again to reactivate the battery.
- The rated output capacity of the battery is measured at 77 degrees Fahrenheit. Any variations in this temperature will alter the performance of the battery. Keep your battery away from high temperatures especially; heat will reduce overall battery life and run time.
- No “break in” period is necessary for our batteries – simply fully charge the battery before first use.

- **Internal Battery Charging:**

- The EBC battery may be charged while i on the bike or removed and charged at another location, with the exception of the Model Y basket battery, which cannot be removed. The battery is easily removed by turning the key switch to the open/unlock position, grasping the rear of the battery, and sliding the battery to the rear of the bike
- To charge the battery, plug the charger into the 110-volt AC outlet. The LED indicator light should be green showing the charger is working normally.
- Then plug the charger into the charging port located on the bottom of the battery by sliding open the charger cover or lifting the handle and inserting the plug.

- **Charging with External Smart Charger:**

- Simply plug the external battery cord into a 110v household outlet.

- **Safety Guidelines for Charging:**

- Charge your bike indoors whenever possible. Charge your battery during the day in a room which has a smoke or fire detector. Do not charge in your bedroom.
- During the charging process, place the battery on a non-flammable surface or leave in the main sleeve.

- Charge in a well-ventilated area. Keep away from flames and sparks.
- Avoid any contact with water or other fluids while charging. If the battery, charger, or any connections become wet, immediately unplug the charger and thoroughly dry all components.
- Never use the internal charger after riding in the rain – wait at least 24 hours before using the internal charger.
- I agree and understand that both the bike and the battery must be switched off before charging. Charging the battery while the bike or battery is in the on position can result in improper charging behavior or damage, including but not limited to battery malfunction, sparking, explosion, or a battery fire. Failure to follow this guideline voids the battery warranty. EBC is not responsible or liable for any damage caused by failing to adhere to this instruction.

- **After Charging:**

- External Smart Charger:
  - Disconnect the power cord from an outlet.
  - Disconnect the charge cord from the battery.
- Internal Charger:
  - Unplug from the 110V plug
  - Allow retractable cord to retract back into battery while keeping a little tension so it goes all the way in
  - Remember to keep cord level and do not twist cord. If the cord gets twisted it will not retract – if this happens, untwist, and try again
  - If the cord does not retract, call your dealer, and do not ride your bike

- **Battery and Charger Care**

- Your EBC Bike Battery comes standard with a Smart Internal Charger (uses best possible charging techniques to ensure longevity of the battery). The external charger will charge a fully depleted battery in 5-6 hours – while the internal charger will charge it within 12-14 hours. The indicator light on the charger will

be red/orange when the battery is charging and will turn green when fully charged.

- Avoid subjecting the battery to high temperatures, such as directly under the sun, for prolonged periods of time. Recharge the battery before it becomes completely discharged. Completely discharging will reduce the numbers of recharging cycles during the battery's life and limit the capacity.
- Never store the battery in the discharged state. After much use, your battery's charge holding capacity will decrease. If you find that your battery does not hold a sufficient charge, you should contact EBC or your local EBC dealer to order a replacement.
- If the battery will not be used for an extended period of time, charge it fully and recharge it every month. Store it in a cool, dry place.
- Your EBC battery is engineered with precision for high capacity and a long, useful life. Do not use it to power other electrical devices. Improper use of the battery will damage the battery and shorten its useful life and may cause fire or an explosion. If you experience unusual sounds or odors coming from the charger or the battery, unplug the charger immediately and contact Electric Bike Company customer service.

## Troubleshooting

- Does Not Illuminate:
  - Make sure your 100-volt wall socket is working. Check the charge power cord. If the charger still does not work, it may need to be repaired or replaced. Do not attempt to open the charger case. Even if the charger is unplugged, you could still be injured by an electrical shock.



## **BATTERY MAINTENANCE AND SAFETY: INSTRUCTIONS PERTAINING TO RISK OF FIRE or ELECTRIC SHOCK**

**Use a regular 100-volt wall outlet to charge your battery. Do not use any other type**

**of outlet, such as an RV outlet or a converter or an inverter, or any other charger not recommended by EBC.** Failure to comply with these instructions could lead to catastrophic consequences, including but not limited to battery malfunction, sparking, explosion or a battery fire. EBC is not responsible or liable for any damage caused by battery misuse and/or charging the battery in any other manner than per EBC instructions.

**WARNING** – When using this product, basic precautions should always be followed, including the following:

- a. Read all the instructions before using the product.
- b. To reduce the risk of injury, close supervision is necessary when the product is used near children.
- c. Do not put fingers or hands into the product.
- d. Do not use this product if the flexible power cord or output cable is frayed, has broken insulation, or any other signs of damage.
- e. This installation is intended to use copper wires only.
  
- f. To reduce the risk of fire, connect only to a charger provided with 4 amperes maximum branch circuit overcurrent & over voltage protection in accordance with the National Electrical Code, ANSI/NFPA 70.
- g. This equipment is not intended to be used at ambient temperatures less than -10°C (14°F) or above ambient temperatures of 55°C (131°F).
- h. The battery is intended to be charged when the ambient temperature is between 0°C (32°F) and 50°C (122°F). Never charge the battery when ambient temperatures are outside this range.
  
- Improper use of the battery charger can cause a fire resulting in severe injury or death and property damage. Please review the following instructions and guidelines carefully to ensure safe battery use and maintenance.
- If you are not going to use your battery for a while, fully charge the battery prior to

turning it off. Be sure to turn on and charge your battery every 2-3 weeks to ensure it never completely loses its charge.

- The battery will get hot to the touch when charging, which is normal; however, if you smell or see any smoke – turn the battery and charger off and unplug anything attached to the battery. Call EBC or your local EBC dealer to obtain a diagnosis or a replacement.
- After a ride, fully recharge your battery as soon as it has cooled to room temperature. If the battery is left in a discharged condition, it will deteriorate much faster than a fully charged battery.
- Do not block the fan vent on the battery pack or external charger. This can cause overheating and fire.
- You should always protect the battery from water and other moisture. Never submerge your bike or battery in water, or even spray the battery with water.
- Keep riding in the rain to a minimum – no more than 5 minutes per day.
- Unplug the charger when the battery is full.
- Only use the internal charger or the external charger supplied with this bike – never ever plug in another charger. Even if it is physically possible to connect another type of battery, it is dangerous (fire hazard) and may damage other components of the bike.
- DO NOT use this battery with any other vehicle or appliance. Use of this battery with any other product will void the warranty and may create a hazardous condition that could cause a fire, resulting in severe injury, death and/or property damage.
- Never disassemble the battery or open the battery case. There is a significant risk of electric shock and damage to the battery. This will also void the warranty.
- Never short-circuit the discharge terminals of the battery. A short circuit will damage the battery and could cause a fire resulting in severe injury, death, and/or property damage. When handling the battery, be aware of conductive materials that may short the battery terminals such as coins, nails etc.
- Never crush or puncture the battery. A punctured or crushed battery could catch fire causing a fire or explosion which could lead to serious injury, death and/or property damage.
- Keep the battery away from excessive heat (104 degrees F or higher) or open

flames. Avoid long-term exposure to direct rays from the sun.

- Protect the battery from materials that may contaminate the charge port or the output port, such as dirt and sand; the ports may be difficult or impossible to clean out.
- Never subject the battery to intense physical shock or severe vibrations.
- Battery moving and storage instructions
  - o When moving and/or storing your battery, it's important to keep the battery safe and prevent short-circuiting:
  - o Store your battery in a well-ventilated area: Lithium-ion batteries do not react well to humidity or excessive heat, so keep your battery away from extreme temperatures: Store batteries in temperatures between 40°F and 80°F, and avoid freezing.
  - o Keep away from heat sources and direct sunlight
  - o Avoid vibration
  - o Keep terminals covered: When the battery isn't in use, keep the terminals covered and prevent them from touching each other.
  - o Keep away from flammables: Store batteries away from flammable and combustible materials.
  - o Failure to adhere to these important instructions may lead to catastrophic consequences, including but not limited to battery malfunction, sparking, explosion or a battery fire.
- Battery Transport:
  - o Lithium-ion batteries are subject to many regulations and are often considered dangerous or hazardous materials by carriers. Be sure to check for relevant laws and ask the carrier for approval prior to shipping a lithium-ion battery or transporting it by air.
- Battery Disposal:
  - o Be friendly to the environment. Be sure to recycle your old batteries at a local battery recycle center. Do not throw them in the garbage. Visit [www.call3recycle.org](http://www.call3recycle.org) for more information.

## Fuse

- Each battery has two fuses: a charge fuse and a discharge fuse. The charge fuse is 5A (Orange) and the discharge fuse is 30A (Green).
- The fuse is designed to protect the battery. If the fuse blows, there will be no power to any of the electrical components powered by the battery. You can replace the fuse with a standard automotive fuse or contact Electric Bike Company customer service for a replacement part at [info@electricbikecompany.com](mailto:info@electricbikecompany.com)

### **Gears – Instructions for Bikes Equipped with 7 Speed:**

- Should you decide to install the 7 speed kit – then:
  - o First gear is for easier and uphill pedaling, and the last gear is for maximum speed on level or downhill terrain.
  - o Change gears only while pedaling.
  - o The rear wheel contains seven chain sprockets. When the chain is around the largest sprocket, you are in 1<sup>st</sup> gear, or the lowest gear. The high gear will have the derailleur positioned so that the chain is directed around the smallest gear.
  - o Every position on the gear selector should cause a gear change.
  - o Adjustments require fine tuning and should only be made by a qualified technician.
- Avoid changing gears very rapidly from first gear to the last gear, or vice versa. If you change multiple gears too quickly, the chain may come off the front sprocket.



**WARNING:** Do not modify or attempt to repair the electrical system of your E-bike, including the battery, charger, motor, and controller. Tampering with these components can create a serious risk of fire, electric shock, or personal injury. Repairs to the electrical system should only be performed by a qualified E-bike technician.



## APPEARANCE AND CARE

Periodically clean your EBC bike with a damp cloth. Do not spray your bike with a water hose to avoid electrical issues. Store your bike in a dry, sheltered area away from the direct sunlight or a wet or damp environment. It is also recommended to apply chain lube (such as Tri-Flow or ProLink) to the drivetrain of your bike when you clean it or wipe it down to keep it in good running condition.

### IF YOU HAVE AN ACCIDENT, DROP YOUR BIKE OR IT FALLS OVER:

If you have an accident, drop your bike or it falls over, your bike is unsafe to ride until you follow the instructions included in this section. Failure to follow these instructions could lead to component or bike operation failure. This could lead to serious injury or death.

1. Check the rechargeable battery. If the rechargeable battery is no longer properly in its holder or shows any damage, do not use your bike any longer, at least not in electrical assistance mode. Switch off the motor and the battery separately, if necessary. Damage to the outer housing of the rechargeable battery can result in the entry of water or moisture, which can lead to a sudden failure of the electric assistance, a short circuit or electrical shocks. The battery could catch fire or even explode!
2. Remove the battery before performing any additional service, inspection, or maintenance on your electric bike. Failure to remove the battery could lead to the bicycle turning on unexpectedly, causing serious damage or injury.<sup>5</sup>
3. Read, understand, and comply with the drive system user manual. Do not disassemble or attempt to service components unless you have been advised how to do so, explicitly in writing, by the EBC manufacturer.
4. Check whether the wheels are still firmly fixed in the dropouts and whether the rims are

still centered with respect to the frame or fork. Spin the wheels and observe the gaps between the frame and tire and between the brake pads and the rim sides.

5. If the width of the gap has changed markedly and you have no way to true the wheel at your location, you will need to release the rim brake pads without touching them. Please note that in this case the brakes may not act as powerfully as you are used to.
6. Check the handlebars and stems to confirm that neither are bent or broken, and that they are level and upright. Make sure the stem is firmly fixed on the fork by trying to turn the handlebars relative to the front wheel. Briefly lean on the brake levers to make sure the handlebars are firmly fixed in the stem.
7. Realign the components, if necessary, and carefully tighten the bolts to ensure reliable clamping of the components. The maximum torque values are printed directly on the

---

<sup>5</sup>If repairs to your bike require the battery to be installed, position the bike so that if the wheel, chain or other drivetrain components begin moving unexpectedly, they will not be in a position to cause injury or damage components and/or specified in these operating instructions. If neither are available, call your local EBC dealer or the EBC manufacturer for assistance.

8. For bikes equipped with 7 speed: Check whether the chain still runs on the chainrings and sprockets. If your bike fell over onto the chain side, check that the gears function properly. Ask someone to lift the bike by the saddle and carefully shift through all the gears. Make sure the rear derailleur does not get too close to the spokes as the chain climbs onto the larger sprockets. If the rear derailleur or the dropout/derailleur hanger is bent, the rear derailleur may collide with the spokes. This can result in damage to the rear derailleur, the rear wheel and/or the frame. Check the function of the front derailleur. A displaced front derailleur can throw off the chain, which will suddenly interrupt the drive of the bike, potentially leading to an accident, injury or death.

9. Confirm the saddle is not out of alignment, using the top tube or the bottom bracket shell as a reference. If necessary open the clamp, realign the saddle and re-tighten the clamp.
10. Let your bike bounce on the ground from a low height. If there is any rattling, see where it comes from. Check the bearings, the bolts and the proper seating of the battery and the connectors, as necessary.
11. Check the display. Are all the values displayed as usual? Do not use your bike if the display shows an error message or a warning. If necessary, switch off the system and wait at least 10 seconds before turning it on and checking it again. **DO NOT SET OFF ON YOUR BIKE WITH DRIVE ASSISTANCE IF THE CONTROL ELEMENT SHOWS A WARNING.**
12. Take a good look at the whole bike to detect any deformation, color changes, cracks. Ride back very carefully or walk your bike back to your dealer or to a professional mechanic and have the mechanic check the bike and help resolve any issues.
13. If you have had an accident and are unsure whether your bike will function properly, leave your bike rather than risk riding and endangering yourself and others.
14. If you do ride your bike, do not accelerate or brake hard until the bike has been checked by a bike mechanic.
15. Deformed components, especially those made of aluminum, can break without previous warning. If this occurs, they may not be repaired, i.e. straightening, as the imminent risk of breakage will remain. This applies in particular to the fork, the handlebars, the stem, the cranks, the seat posts and the pedals. When in doubt, you should replace these components.

## TROUBLESHOOTING

If your Electric Bike Company Bike is not working, check the Quick Disconnect Fittings to make sure they did not come loose or unplugged.



There are 5 total colored Quick Disconnect Fittings to check:

1. Throttle –Yellow
2. Left Brake Lever – Red
3. Right Brake Lever – Red
4. Motor - Black
5. LCD Meter – Green

Simply unwrap the black spiral wire covering until the Quick Disconnect Fitting is exposed. If necessary, unplug and replug the Quick Disconnect Fitting (s).

Make sure the battery is inserted fully into the bicycle. If it is not, the bicycle will receive no power causing all of the electronics to not turn on.



For any additional troubleshooting help, refer to the Customer Help page at [www.electricbikecompany.com](http://www.electricbikecompany.com) or contact your local Electric Bike Company dealer.

**“PLEASE SAVE THESE IMPORTANT SAFETY INSTRUCTIONS.”**

## ELECTRIC BIKE FAQs

Q. How long does it take to fully charge the battery?

A. Depends on the state of discharge, but around 5-6 hours if completely discharged. For the internal charger 12-14 hours

Q. What are the running costs for an EBC Bike?

A. You will have no worries about rising fuel prices at the pumps. All our electrically powered vehicles use household electricity. The average cost per full charge is about 10 cents per charge. If you charge the battery every single day for a year, it would cost you about \$35 per year.

Q. Can I ride up hills and against strong headwinds on my EBC Bike?

A. Yes. One of the main advantages of cycling on an Electric Bike Company Bike is that it literally flattens hills and increases your average speed when tackling inclines and headwinds. If you provide a reasonable amount of effort, you should be able to tackle anything from a 1 in 10 (10%) gradient up to a 1 in 7 (14%) gradient. You will be amazed at the relative ease that your new Electric bike can tackle some of the most arduous journeys.

Q. Do I need a driver's license, insurance or registration?

A. No, you don't. According to Federal Law, electric bikes that are under 750 watts are classified as bicycles. For all intents and purposes, it's simply a bicycle that requires very little pedaling to travel 20 MPH (32 Km/H), saving you time and hassle. The law in some states does require the use of a helmet and riders to be at least 16 years old. Check your local state laws for requirements.

Q. Do I need to pedal an electric bike?

A. No, but it helps to prolong battery life. The motor on our bikes is both throttle and pedal assist controlled, allowing you to decide how much power you desire. Have you ever tried to cycle when speeding downhill on your normal bicycle? It's just like that, the motor is propelling you faster than you're cycling so there is pretty much no resistance.

Q. What happens when I use the brakes under powered assistance?

A. All our bikes are equipped with brake levers that have a built-in safety switch that automatically cuts off the motor power under normal braking conditions. This not only ensures a safe un-powered stopping feature, but also protects the motor under braking conditions so that it isn't working against the brakes.

Q. How far will my EBC Bike take me?

A. This all depends on a few factors. Cycling with pedal assist along a straight road under normal conditions, the standard battery should last about 15-30 miles (24-48 kilometers). Cycling up steep hills will obviously take more energy out of the battery and factors such as road surface, wind resistance, weight of the rider and tire pressure will affect your range. Longer range battery is also available.

Q. What happens if I get a flat tire?

A. The tires on our bikes are the same as conventional bicycles. Simply replace the tube with a tube of the right size and inflate it. No special tires or parts will be needed.

Q. How do I know when the battery is low?

A. The bicycles have easily visible indicators located on the LCD screen that show the amount of juice left. If it is getting low and you don't think you will make it to your destination, you can switch off your motor and keep it just for the difficult bits.

Q. Do I have to wait for the battery to empty before I charge it?

A. No. The batteries we use are Lithium-ion batteries which do not suffer from memory effects. This means that there is no need to discharge a battery completely before you recharge it again. You can partially recharge the battery at any time without reducing its voltage or lifespan. We recommend recharging the battery after every use, regardless of how far you rode.

Q. Can I put an EBC Bike on a vehicle bike rack?

A. Yes, just make sure that the bike rack can hold the weight of an electric bike weighing approximately 60-70 lbs. We advise taking the battery off to make it easier and lighter to lift

and keep the battery safe.



# THE LIFESPAN OF YOUR ELECTRIC BIKE AND ITS COMPONENTS

Nothing lasts forever, including your electric bike.

- When the useful life of your bike or its components is over, continued use is hazardous.
- Every bicycle and its components have a finite, limited useful life. The length of that life will vary with the construction and materials used in the frame and components; the maintenance and care the frame and components receive over their life; and the type and amount of use to which the frame components are subjected.
- Non-authorized uses, including competitive events, trick riding, riding on severe or off-road terrain, riding in severe climates, riding with heavy loads, commercial activities and other types of non-standard use can dramatically shorten the life of the frame and components. Any one or a combination of these conditions may result in an unpredictable failure.

Perspective:

- Today's high-performance bicycles require frequent and careful inspection and service. In this section we explain some underlying material science basics and how they relate to your bicycle. We provide important, basic guidelines on how to maintain and inspect your bicycle. We cannot teach you everything you need to know to properly inspect and service your bicycle. That is why we repeatedly urge you to take your bicycle to your dealer for professional care and attention.
- You, the rider/owner, have control and knowledge of how often you use your bike, how hard you use it and where you use it. Because neither EBC nor your local EBC dealer cannot track your use, you must take responsibility for periodically bringing your bike to your dealer for inspection and service. Your dealer will help you decide the frequency of inspection and service appropriate for as a result of your particular use of your bike.

## WARRANTY INFORMATION

Your warranty is contained below. Please be sure to read the warranty in its entirety and register for your warranty on the EBC website at <https://electricbikecompany.com/registration-warranty-return/>.

### YOU MUST REGISTER YOUR ELECTRIC BIKE WITH EBC WITHIN 30 DAYS FOR WARRANTY TO BE VALID

Like any mechanical device, a bicycle and its components are subject to wear and stress. Different materials and mechanisms wear or fatigue from stress at different rates and have different life cycles. If a component life cycle is exceeded, the component can suddenly and catastrophically fail, causing serious injury or death to the rider. Scratched, cracks, fraying and discoloration are signs of stress-caused fatigue and indicate that a part is at the end of its useful life and needs to be replaced. While the materials and workmanship of your bicycle or of individual components may be covered by a warranty for a specific period by the manufacturer, this is no guarantee that the product will last the term of the warranty. Product life is often related to the kind of riding you do and to the treatment to which you submit the bicycle and the standard of maintenance and care you have for your bike. The bicycle's warranty is not meant to suggest that the bicycle cannot be broken or will last forever. It only means that the bicycle is covered subject to the terms of the warranty.

## LIMITED WARRANTY

### **30 days Limited Warranty Bicycle Components**

EBC warrants that all new EBC bicycles and components therein are warranted to the original retail purchaser ("Purchaser") against manufacturing defects in materials and/or workmanship for a period of 30 days from the date of original retail purchase.

### **Two Year Limited Warranty Battery**

EBC warrants to the original Purchaser that the battery is free of defects in material and

workmanship for 2 years or 24 months. The defective product will be replaced or repaired if met under certain pre-conditions. The first month of the warranty is covered free of charge, the remaining months are covered under a pro-rated cost. The warranty period for a battery is calculated from the original battery purchase date. The original receipt of purchase is required to establish proof of purchase and warranty date and must be provided to EBC for all warranty claims.

The original battery sale receipt must be maintained for any further claims. All replacement batteries will be warranted for the balance of the original warranty period.

The Purchaser is responsible for paying the following costs associated with the replacement: labor for removal or installation; applicable taxes; and any shipping or transportation costs incurred in returning the battery to EBC for evaluation.

EBC offers a 2 year warranty against manufacturer defects, but if the consumer fails to charge the battery regularly and it goes dead overtime – the consumer will not be able to recharge him or herself. Consumers will either need to purchase a new battery or send the battery back to EBC for repair. Consumers can either drop off and pick up the battery for free or pay for shipment of the battery to be shipped to and from our location for repair. There is no repair cost or exchange cost to fix or exchange the battery within the first 30 days if malfunction is determined to be due to a manufacturer defect. After 30 days, the parts for each battery repair cost will be waived and all warranty related labor charges will be at the standard EBC rate if the customer drops off their battery or ships it back at their expense, including a return label. If a consumer opts to exchange the battery instead of having it repaired, the cost of an exchange is \$399 for a standard battery and \$499 for an upgraded battery. Consumers will receive a new battery and EBC will retain the old battery.

Consumers are responsible for the shipping costs of a battery exchange. After 2 years, consumers will need to pay the full retail price of a new standard or upgraded battery. Water damage is not covered under this warranty.

## **LIMITATIONS ON WARRANTY:**

THIS IS ELECTRIC BIKE COMPANY'S EXCLUSIVE WARRANTY, NO PARTY IS GRANTED EXPRESS OR IMPLIED AUTHORITY TO CHANGE OR ANNUL THIS WARRANTY IN ANY MANNER, IMPLIED WARRANTIES INCLUDING THAT OF MERCHANTABILITY AND FITNESS FOR A PARTICULAR PURPOSE ARE EXPRESSLY LIMITED IN DURATION TO THE DURATION OF THIS WARRANTY, EBC DISCLAIMS ANY LIABILITY FOR SPECIAL, INCIDENTAL OR CONSEQUENTIAL DAMAGES.

### **Terms of Limited Warranty**

The warranty becomes effective on the date of the original retail purchase. The warranty is not meant to suggest or imply that the Bikes cannot be broken or will last forever. It does mean that the Bicycle is covered subject to the terms of the warranty. This warranty applies only to the original Purchaser of the EBC Bicycle and is not transferable to subsequent owners or any other party. This warranty is void if the Bicycle is subjected to abuse, neglect, improper repair, improper maintenance, alteration, modification, an accident or other abnormal, excessive or improper use, at the sole discretion of EBC. During the duration of this warranty, EBC, at their cost, will either repair the Bicycle or Bicycle component(s), or at EBC's sole discretion, will replace any defective Bicycle or component(s). with the same or equivalent component(s). The foregoing warranties are in lieu of and exclude all other warranties not expressly set forth herein, whether express or implied by operation of law or otherwise, including, but not limited to any warranties of merchantability or fitness for a particular purpose. In no event shall EBC be liable for incidental, consequential or punitive damages arising from use or unavailability of the Bicycle or component(s) in any manner, including, without limitation, damages for personal injury, property damage, or economic

losses, whether based on contract, warranty, negligence, product liability, or any other theory. EBC's liability hereunder is expressly limited to the repair or replacement of Bikes or component(s) or at EBC's sole discretion, to the net amount paid to the original retail Purchaser. If the original retail Purchaser elects to repair a defective Bicycle or component(s) himself or use the services of someone other than EBC (or its designee) to repair the Bicycle or if Purchaser uses a replacement part not authorized by EBC, EBC will not be liable for any damage, failure or loss caused by the use of such unauthorized service or parts. Warranty terms, service availability, and service response times may vary from state to state, country or region. Warranty service response time is subject to change due to local parts availability. Your EBC authorized service provider can provide you with additional details. EBC will not alter the form or function of this EBC bicycle to make it operate in a country for which it was never intended to function for legal or regulatory reasons. EBC is not responsible for any tariffs or duties that may be incurred in transferring the products. Transfer of the products may be covered by export controls issues by the United States or other governments.

THIS WARRANTY IS VOID IN ITS ENTIRETY WITH ANY MODIFICATION OF THE FRAME, FORK, OR ANY COMPONENTS. THIS WARRANTY IS LIMITED TO THE REPAIR OR REPLACEMENT OF A DEFECTIVE ITEM AND IS THE SOLE REMEDY OF THE WARRANTY. THIS WARRANTY EXTENDS FROM THE DATE OF PURCHASE, APPLIES ONLY TO THE ORIGINAL OWNER AND IS NOT TRANSFERABLE.

This warranty does not cover:

- Normal wear and tear
- Damage or failure from abuse, neglect, misuse, or accident
- Improper assembly and/or follow-up maintenance
- Damage from stunt riding, jumping, acrobatics, or similar activities or any activity that is not consistent with the intended use of the bicycle

- Damages resulting from failure to follow instructions for the Use and Warnings as provided in the Operator's Manual
- Damages resulting from improper care or use of the battery or charger
- Installation of components, parts, or accessories that are not originally intended for or compatible with the EBC bicycle as sold
- Under performance of the battery after being fully charged and discharged more than 500 times

All warranties are void if the Bicycle is used for any purpose other than the reasonable intended use of the Bicycle. Additionally, this warranty does not cover damage associated with commercial use.

## TERMS AND CONDITIONS OF PURCHASE AND USE

Electric Bike Company has agreed to sell EBC bicycle(s) and/or other bike accessories, either directly or through a third party affiliate/retail dealer to Purchaser as reflected in the attached sales invoice. (Electric Bike Company and any relevant third party affiliate/retail dealer will be referred to herein collectively as "EBC.") EBC and the Purchaser shall be referred to hereafter as "the Parties." This Contract of Sale, Waiver and Release from Liability shall be referred to hereafter as the "Contract."

Purchaser agrees and understands that EBC cannot oversee or supervise the safety and proper usage of Purchaser's EBC electric bicycle(s) and accessories. Consequently, EBC cannot be held responsible for the safe use or other actions by the Purchaser and/or future riders of EBC electric bicycles.

Purchaser, being above 16 years of age, agree to all terms as follows:

When riding my EBC bicycle(s), I agree to obey the electric bike federal and state speed limitation laws and all other state, county, municipal and city traffic laws where I choose to ride, including all electric bicycle laws. I understand that EBC has provided me with a Class 2 E-bike. Should I desire to convert my bike to a Class 1 or Class 3, I understand that I need to contact EBC for instructions (or follow the instructional video located on the EBC website). Should I convert the bike to a Class 3, I understand that it is my responsibility to disconnect the throttle. I also understand that it is my responsibility to ensure my EBC e-bike is in compliance with my state, city or municipal laws, rules or regulations including those that may require my EBC bike to be Class 1 or 2. I agree and understand that EBC takes no responsibility for any liability I incur as a result of my failure to insure my EN+BC bike is in compliance with all state, county, municipal and city traffic laws where I choose to ride, including all electric bicycle laws.

EBC E-bikes leave the EBC factory with the classification of a Class 2 E-bike under federal law, and have the ability to be reprogrammed by the User as Class 1 or 3, to enable the consumer to adjust and insure compliance with applicable federal, state and local bike safety laws. Every EBC E-bike includes a motor of less than 750 watts (749-750 watt motor), which may be rounded up to 750 watts in EBC promotional materials for descriptive simplicity.

I agree and acknowledge that EBC e-bicycles are intended for use by one rider only and are not designed nor safe to be used to carry a second passenger.

I agree and acknowledge that anyone with serious medical conditions should not ride an electric bike.

I agree and acknowledge that no one, including myself, should ride an electric bike while under the influence of alcohol or drugs, including prescription medications, or while otherwise incapacitated.

I agree and acknowledge that if I am not satisfied with my EBC bike, that I can return it within 30 days of receiving it for a refund and a \$600 restocking fee will be deducted from my refund. I also agree and acknowledge that I can only return it if the EBC ebike has less than fifty (50) miles on the odometer, be free of any wear and tear, dirt, dust, fragrance, or any other signs of use and must be in the same packaging and condition that I received it and must include all items that were inside the box (charger, keys, alarm fobs, etc.).

I agree and acknowledge that it is not safe to ride EBC bicycles in hazardous conditions, including uneven or off road terrain, significant rain or in snow. I agree and acknowledge that my vision can be impaired when riding my e-bike at night or at dusk/dawn when there is less light available, and that I should maintain a speed of no more than 20mph in any of these conditions. I assume all risks of riding my EBC bicycle(s) under these and/or any other unsafe conditions.

I acknowledge and understand that riding an EBC bicycle is a dangerous activity that requires moderate to strenuous exercise and various degrees of skill and experience for individual riders. I understand that biking can result in serious injury to the person and damages to property. I hereby voluntarily assume any and all risk associated with loss, damage or physical injury that occurs while riding my EBC bicycle(s). I also acknowledge and agree to charge my battery with a regular wall outlet and not any other type of outlet, such as an RV outlet, inverter, converter, or any charger not recommended by EBC. I hereby voluntarily assume any and all risk associated with loss, damage, or physical injury that occurs by charging my battery against the recommendations of EBC.

I agree and understand that I must use a regular wall outlet to charge my battery. I agree not to use any other type of outlet, such as an RV outlet or a converter or an inverter, or any other charger not recommended by EBC. I agree and understand that I should not leave my battery charging unattended or for an extended period of time. I agree and understand that failure to comply with these instructions could lead to catastrophic consequences, including but not limited to battery malfunction, sparking, explosion or a battery fire. I agree and understand that EBC is not responsible or liable for any damage caused by battery misuse and/or charging the battery in any other manner than per EBC instructions.



I agree and understand that both the bike and the battery must be switched off before charging. Charging the battery while the bike or battery is in the on position can result in improper charging behavior or damage, including but not limited to battery malfunction, sparking, explosion, or a battery fire. Failure to follow this guideline voids the battery warranty. EBC is not responsible or liable for any damage caused by failing to adhere to this instruction.

I agree and understand that I must charge my battery at least every 3 weeks when not in use and failure to do so will result in the lithium battery cells dying and void the battery warranty. I agree and understand that water damage is not covered under the warranty. I agree and understand that EBC advises that after 2 years, I should send my battery to EBC for service or replacement. I agree and understand that leaving my battery on my bike, whether locked or unlocked, leaves it susceptible to theft, and best practice is to remove the battery when my bike is left in public unattended. I agree and understand that EBC takes no responsibility thereafter for battery degradation or malfunction and that failure to properly maintain or replace battery after 2 years could result in catastrophic consequences, including but not limited to battery malfunction, sparking, explosion or a battery fire. I agree and understand that the purpose of the key(s) that come with my battery is to secure the battery in place while riding, and to remove the battery in order to charge it externally or transport it separate from my e-bike. I agree and understand that EBC takes no responsibility for battery theft or tampering that may occur when my battery is left on my bike in public and unattended.

**Important Update to EBC Battery Repair Policy:** At Electric Bike Company, customer safety and satisfaction are our top priorities. After careful consideration, EBC has decided to change its battery repair process to better serve you and ensure the highest safety standards.

**What's Changing?** EBC will no longer open and repair the internal components of battery packs. This decision is due to the high skill level and safety risks involved in such repairs. Instead, for all warranty-related battery issues, EBC will now provide a brand new, sealed battery pack.

**What Does This Mean for You?** For any battery-related warranty claims, you will receive a brand new battery pack. There will be a minimum labor fee of \$399 for this service, which is a very good deal considering EBC's top-rated batteries retail from \$799 to \$999. This special pricing will last throughout this year. When a battery pack is replaced under warranty, the new battery pack will come with a full one-year warranty from the date of replacement.

EBC believes this new policy will provide a safer and more efficient solution for maintaining your e-bikes in top condition. Thank you for your understanding and continued support. If you have any questions, please don't hesitate to reach out to our customer service team.

**Battery Replacement and Safety Standards:** EBC is committed to providing customers with the latest advancements in battery technology and safety. Battery technology and safety standards are continuously evolving. Newer batteries incorporate the latest safety features, reduce the risk of malfunctions or hazards, ensure your e-bike stays updated with the latest legally compliant certifications and standards, and optimize e-bike performance, provide additional safety, longevity, and reliability. . To maintain the highest e-bike safety and performance standards, as well as to take advantage of the latest technological advancements, EBC strongly recommends and requires customers to replace their e-bike batteries at least every five years. For further information on EBC's battery replacement program, please contact the EBC customer service team at (949) 264-4080.

I agree and understand that if I own/have purchased a legacy Model C or S, that I will not use an external charger to charge the battery using the small charging port located underneath the battery without prior approval from EBC. I agree and understand that if I own/have purchased a Model Y, I will only use the charging port located on the side of the basket to charge the battery and not the charging port located underneath the basket without prior approval of EBC. I agree and understand that failure to comply with these instructions could lead to catastrophic consequences, including but not limited to battery malfunction, sparking, explosion or a battery fire. I agree and understand that EBC is not responsible or liable for any damage caused by charging the battery in any other manner than per EBC instructions.

I agree, acknowledge and understand that EBC e-bikes require regular maintenance (every 3 months), including but not limited to ensuring proper tire pressure, brake maintenance and tune-ups. I agree, acknowledge and understand that only EBC-approved parts should be used for maintenance and/or replacement parts on my EBC e-bike. Failure to adhere to these instructions could render my EBC e-bike unsafe and voids the warranty. I agree and understand that EBC is not responsible or liable for any damage caused by failure to properly maintain my EBC e-bike and/or use EBC approved parts in replacing parts or repairing my EBC e-bike.

I am aware of the risks, hazards and dangers of personal injury, death and disability inherent in the use of electric bicycles, including EBC bicycles. I am aware that the usual risks, hazards and dangers of personal injury, disability and death are greater with lack of experience and/or failure to follow the warnings and instructions provided by EBC in its Operator's

Manual and within the manuals accompanying the various components of the EBC bicycle, access to which have been provided to me by EBC under the website "Contact Us" page in the "Customer Resources" section.

I agree, acknowledge and understand that a helmet is an important safety accessory, and that I should wear a helmet, with the straps adjusted properly and fitted snugly to my head, at all times while operating my EBC e-bike. I agree, acknowledge and understand that a helmet is required for any person operating my EBC e-bike who is under the age of 18. I am aware of the risks, hazards and dangers of personal injury, death and disability inherent in the use of electric bicycles, and that failure to ride with an appropriately working helmet increases the likelihood of personal injury, death and/or disability related to blunt force head trauma.

I hereby agree to release and forever discharge EBC, and its agents, employees, officers, directors, component manufacturers and any and all other persons or entities acting on EBC's behalf from any and all legal claims, actions, damages, liability, costs, expenses or attorney fees related to, arising out of, or in any way connected to use of my EBC bicycle(s), use of any other equipment or property supplied by EBC or from any claim arising out of my presence upon the EBC premises, whether or not such claims, actions, damages, liability, cost or expenses are caused by the negligence of EBC, including its agents, employees, officers, directors, component manufacturers and/or any and all other persons or entities acting on EBC's behalf. By my execution of this Contract, it is my intention to surrender and waive any and all rights to sue or to exercise a legal right to seek damages from EBC, and/or its agents, employees, officers, directors, component manufacturers and any and all other persons or entities acting on EBC's behalf.

I hereby certify that I am at least 16 years of age. I acknowledge that no person under the age of 14 is permitted to ride an e-bike in the United States. I acknowledge that there are varying state laws and regulations that apply to persons under 16 years old riding an electric bicycle, including an EBC bicycle. For example, in the state of California a rider needs to be at least 16 years old to ride a Class 3 electric bike that can reach 28 mph or greater. Consequently, in California, should I intend to allow a person under 16 years of age to ride my EBC e-bike, I must seek assistance with my EBC e-bike set up and adjust the speed parameters of my bike accordingly. I have carefully read the foregoing and acknowledge, understand and AGREE to all of the above terms and conditions. I have had the opportunity to ask any and all questions regarding this Contract. By issuing payment for my EBC bicycle(s) and executing this Contract, I assume all risks inherent in the purchase and use of an electric bicycle, and release EBC from any and all liability that may arise from my ownership and use of my EBC bicycle(s). This includes a release of EBC from any and all liability related to or arising out of a minor's use of my EBC bicycle(s).

Binding Arbitration Clause: The Parties agree that any dispute, controversy or claim arising out of or relating to this Contract or as a result of the use of EBC bicycle(s) and accessories; including warranty claims, defective product claims, physical injury claims, property damage claims and/or whether any of the aforementioned claims are arbitrable, will be referred to and finally determined by arbitration. The tribunal will consist of a sole arbitrator. The place of arbitration shall be located in Orange County, California. Judgment upon the award rendered by the arbitrator may be entered by any court having jurisdiction thereof. In the event a party fails to proceed with arbitration as delineated in this paragraph, unsuccessfully challenges the arbitrator's award, or fails to comply with arbitrator's award, the other party is entitled to costs of suit including reasonable attorneys' fees for having to compel arbitration or defend or enforce an award.